

---

# **CF 3011**

## **Digital Panel Meter**

**Universal Counter/Timer/Frequency Meter**

**Instruction Manual**

---



**ERMA**

Electronic GmbH

**Warranty**

For delivered products our "Allgemeine Lieferungs- und Zahlungsbedingungen" are effective. In no event ERMA-Electronic or its suppliers shall be liable for any other damages whatsoever (including, without limitation, damages for loss of business profits, business interruption or other pecuniary loss) arising out of or inability to use this product.

All products from ERMA-Electronic are warranted against defective material and workmanship for a period of two (2) years from date of delivery. If it is necessary to return the product to ERMA, the sender is responsible for shipping charges, freight, insurance and proper packaging to prevent breakage in transit. ERMA's warranty does not apply to defects resulting from action of the buyer, such as mishandling, improper interfacing, operation outside of design limits, improper repair or unauthorized modification.

**Trademarks**

All trademarks they are named or portrayed in the text are registered trademarks of its owner. The trademarks are recognized by ERMA-Electronic.

---

# CONTENTS

|   |           |
|---|-----------|
| <b>1. Description</b>                             | <b>4</b>  |
| <b>2. Safety instructions</b>                     | <b>5</b>  |
| 2.1. Explanation of symbols                       | 5         |
| <b>3. Mounting</b>                                | <b>6</b>  |
| 3.1. Place of operation                           | 6         |
| 3.2. Panel mounting                               | 6         |
| 3.2.1. Panel for switch board                     | 6         |
| 3.2.2. Panel for mosaic systems                   | 7         |
| <b>4. Electrical connections</b>                  | <b>8</b>  |
| 4.1. General instructions                         | 8         |
| 4.2. Hints against noisy environment              | 8         |
| 4.3. Connection and pin assignment                | 9         |
| 4.4. Connection of digital input signals          | 10        |
| 4.4.1. Mode chronometer / stop-watch              | 10        |
| 4.4.2. Mode pulse counter forward / backward      | 10        |
| 4.4.3. Period length / pulse duration measurement | 10        |
| 4.4.4. Mode frequency / revolutions measurement   | 10        |
| 4.4.5. Mode operating hours meter                 | 11        |
| 4.4.6. Mode speed indicator                       | 11        |
| 4.4.7. Digital inputs                             | 11        |
| 4.5. Connection of alarm output                   | 12        |
| 4.6. Connection of power supply voltage           | 12        |
| <b>5. Start-Up</b>                                | <b>13</b> |
| <b>6. Procedure of programming</b>                | <b>14</b> |
| 6.1. Summary of the programming level             | 16        |

---

|            |  |           |
|------------|--|-----------|
| 6.2.       | Programming level for configuration P-00 . . . . . | 17        |
| 6.3.       | Programming level of alarms P-03 . . . . .         | 20        |
| 6.3.1.     | Alarm high setpoint . . . . .                      | 22        |
| 6.3.2.     | Alarm low setpoint . . . . .                       | 23        |
| 6.4.       | Programming quick reference . . . . .              | 23        |
| <b>7.</b>  | <b>Review of modes . . . . .</b>                   | <b>23</b> |
| 7.1.       | Chronometer / stop watch . . . . .                 | 23        |
| 7.2.       | Pulse counter forward . . . . .                    | 23        |
| 7.3.       | Pulse counter backward . . . . .                   | 25        |
| 7.4.       | Period length measurement . . . . .                | 26        |
| 7.5.       | Pulse duration measurement . . . . .               | 26        |
| 7.6.       | Frequency measurement . . . . .                    | 27        |
| 7.7.       | Revolutions per minute . . . . .                   | 27        |
| 7.8.       | Operation hours meter . . . . .                    | 28        |
| 7.9.       | Speed indicator with m/s . . . . .                 | 29        |
| 7.10.      | Speed indicator with km/h . . . . .                | 29        |
| <b>8.</b>  | <b>Software functions . . . . .</b>                | <b>30</b> |
| 8.1.       | Filtering for pulse counter modes . . . . .        | 30        |
| 8.2.       | Exceeding of the measuring range . . . . .         | 30        |
| 8.3.       | Display test . . . . .                             | 30        |
| <b>9.</b>  | <b>Technical Specifications . . . . .</b>          | <b>31</b> |
| <b>10.</b> | <b>Ordering information . . . . .</b>              | <b>33</b> |

Stand : 02.02.02  
CF3011AE.PUB  
Subjects to technical modifications

### **1. Description**

The totalizing counter model **CF 3011** is an universal instrument for measuring **time-dependent signals**. There are following modes available:

- Chronometer with start and stop input
- Pulse counter with direction-input
- Period length measurement
- Pulse duration measurement
- Frequency measurement up to 10kHz
- Revolutions per minute
- Operating hours meter
- Speed indicator with m/s or km/h

#### **Standard hardware**

- Four programmable digital input channels
- One alarm output channel

#### **Standard software**

- Scale factor 0,001 .. 9,999
- Offset value for counter mode
- Max. counter frequency 15 Hz, 7 kHz programmable
- Programmable decimal point
- Autoranging
- Rounding last digit with 1, 2, 5, or 10 digit steps
- Display test

## 2. *Safety instructions*

This instrument is produced in accordance with Class II of IEC 348 and VDE 0411. When delivered the instrument has been tested to meet all functions described. Before installing the instrument please read the mounting and servicing instructions.

We have no liability or responsibility to customer or any other person or entity with respect to any liability, loss or damage caused or alleged to be caused directly or indirectly by equipment or software sold or furnished by us. Read the installation instruction carefully. No liability will be assumed for any damage caused by improper installation.

Inspect the instrument module carton for obvious damage. Be shure there are no shipping and handing damages on the module before processing. Do not apply power to the instrument if it has been damaged.

ERMA's warranty does not apply to defects resulting from action of the buyer, such as mishandling, improper interfacing, operation outside of design limits, improper repair or unauthorized modifications.

### 2.1. *Explanation of symbols*



**Caution**



**Attention**



**Instruction**



**Hint**

**Caution:**            **Dangerous!**

**Attention:**        Will cause **damage**

**Instruction:**     If not noticed, **trouble** may occur

**Hint:**              Useful hints for **better operation**

### 3. Mounting

#### 3.1. Place of operation

Attention must be paid to the protection against humidity, dust and high temperatures at the place of operation.

#### 3.2. Panel mounting

##### 3.2.1. Panel for switch board

- For mounting in switch boards, insert the case into the panel cutout (according to DIN 43700:  $92,0^{+0,8} \times 45,0^{+0,6}$  mm) from the front, using a fresh gasket for sealing as required. Click into and place at each side the two fastening clips (M2,5 x 50 mm).
- Tighten the screws alternately, using enough pressure to get good retention and sealing at the panel.

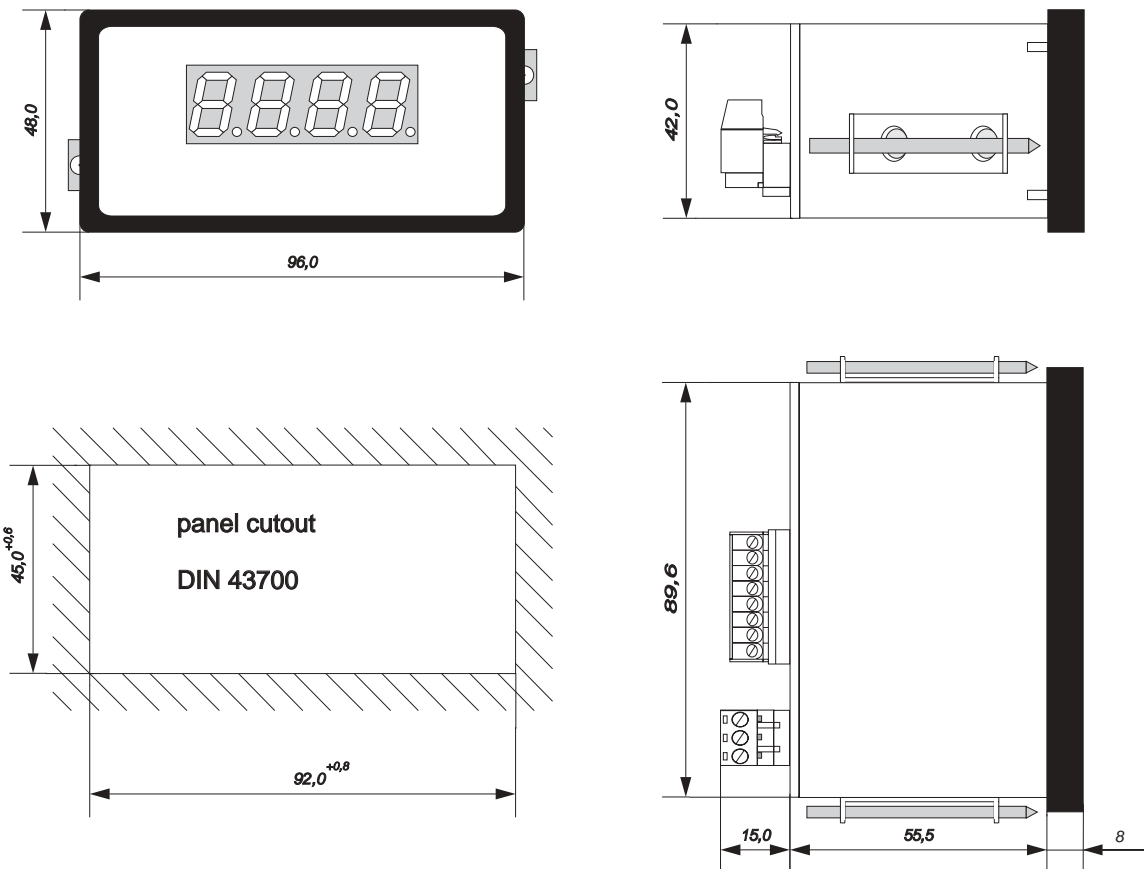

### 3.2.2. Panel for mosaic systems

- Insert the case into the following mosaic-system:

a) Mosaic-system from Subklev

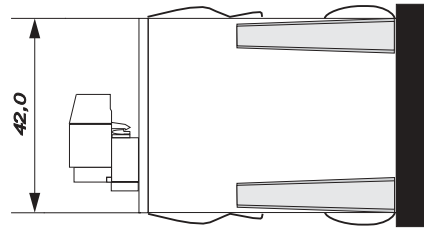
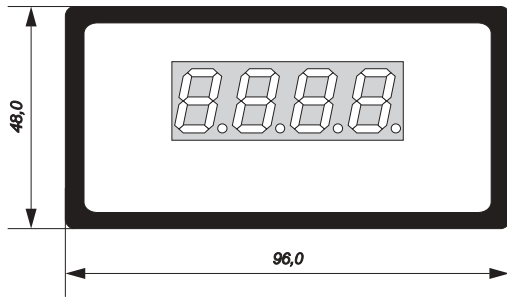

mosaic-system:  
Siemens 8RU (M50x25)  
Subklev

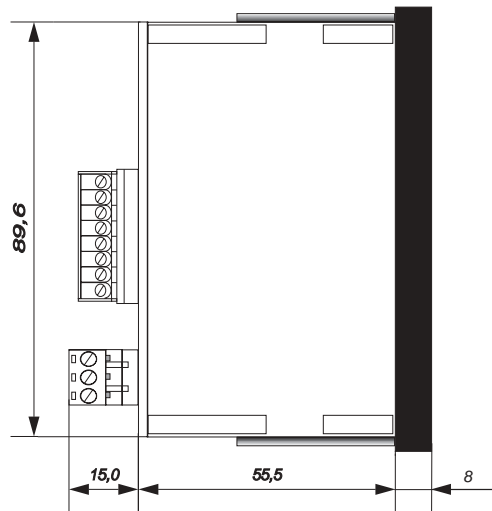



## 4. *Electrical connections*

### 4.1. *General instructions*



- It is forbidden to plug or unplug connectors with voltage applied
- Attach input and output wires to the connectors only without voltages applied
- Cords must be provided with sleeves
- Attention must be paid that the power supply voltage applied will agree with voltage noticed at the name plate.
- The instrument has no power-on switch, so it will be in operation as soon as the power is connected.

### 4.2. *Hints against noisy environment*

All inputs and outputs are protected against noisy environment and high voltage spikes. Nevertheless the location should be selected to ensure that no capacitive or inductive interference can have an effect on the instrument or the connection lines.

#### **It is advisable:**



- To use shielded cables.
- The wiring of shields and ground (0V) should be star-shaped.
- The distance to interference sources should be as long as possible. If necessary, protective screen or metal enclosures must be provided.
- Coils of relays must be supplied with filters.
- Parallel wiring of input signals and AC power lines should be avoided.

### 4.3. Connection and pin assignment

All inputs and outputs are connectors, designed as plug-in screw terminals.

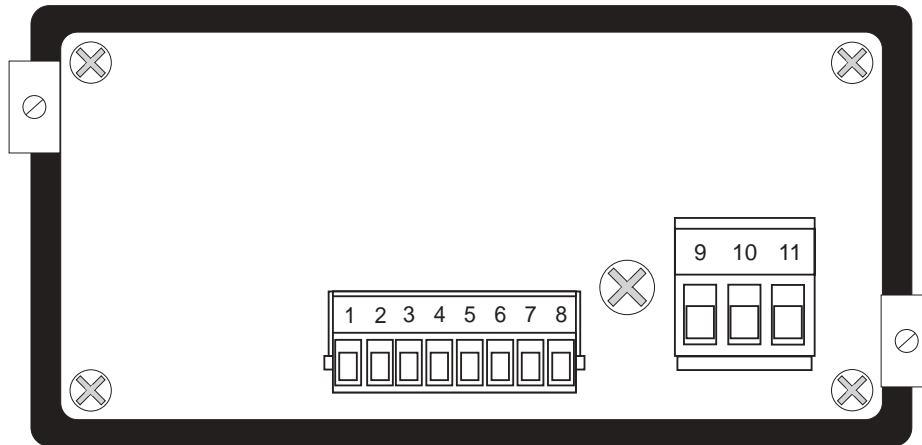

#### Pin assignment:

|    |                                |    |                    |
|----|--------------------------------|----|--------------------|
| 01 | Optocoupler (Emitter)          | 09 | GND                |
| 02 | Optocoupler (Collector)        | 10 | supply voltage (-) |
| 03 | digital input 1 / display test | 11 | supply voltage (+) |
| 04 | digital input 2                |    |                    |
| 05 | digital input 3                |    |                    |
| 06 | digital input 4                |    |                    |
| 07 | signal input                   |    |                    |
| 08 | signal ground                  |    |                    |

## 4.4. Connection of digital input signals

### 4.4.1. Mode chronometer / stop-watch

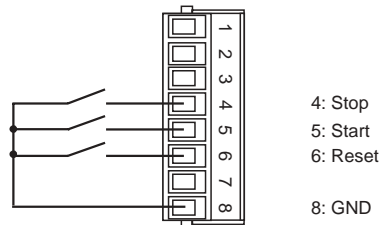

### 4.4.2. Mode pulse counter forward / backward

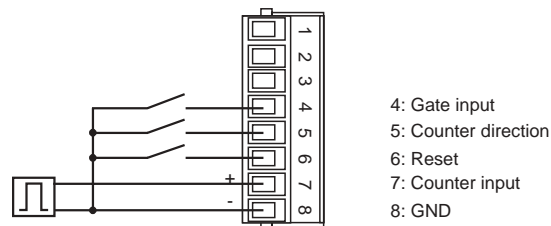

### 4.4.3. Period length / pulse duration measurement

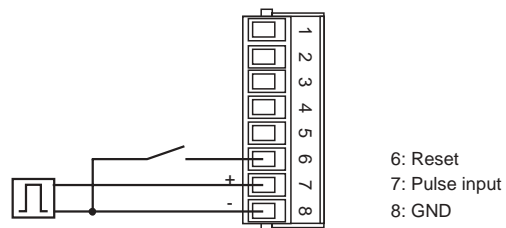

### 4.4.4. Mode frequency / revolutions measurement

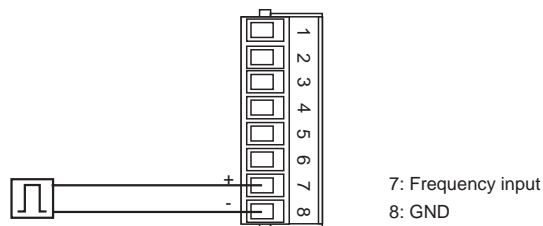

### 4.4.5. Mode operating hours meter

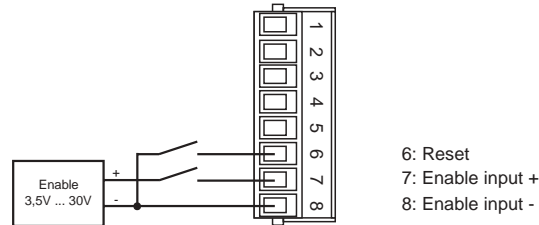

### 4.4.6. Mode speed indicator

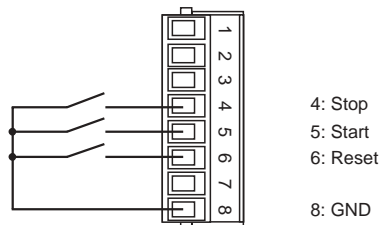

### 4.4.7. Digital inputs

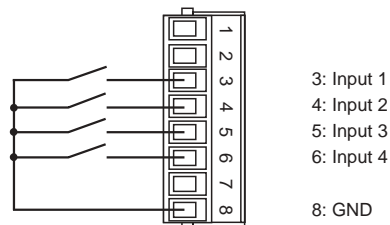

#### Digital input 1

- active => connecting screw terminal 3 to 8
- connecting to ground, low-active

#### Digital input 2

- active => connecting screw terminal 4 to 8
- connecting to ground, low-active

### Digital input 3

- active => connecting screw terminal 5 to 8
- connecting to ground, low-active

### Digital input 4

- active => connecting screw terminal 6 to 8
- connecting to ground, low-active

## 4.5. Connection of alarm output

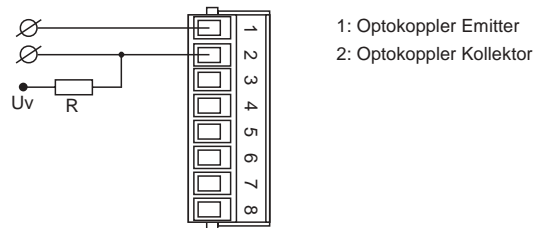

## 4.6. Connection of power supply voltage

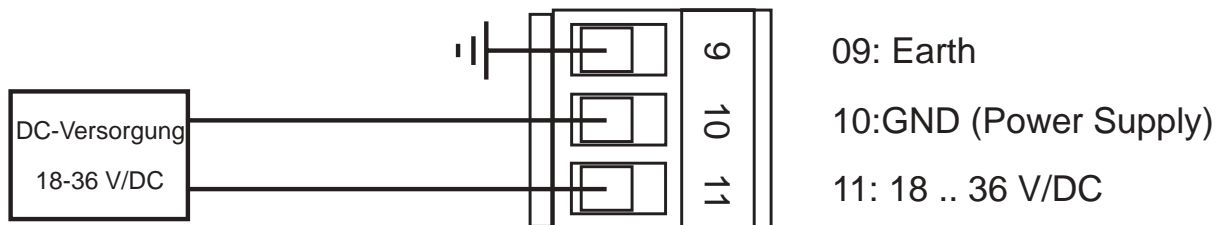

## 5. ***Start-Up***



**Attention must be paid that the power supply voltage applied will agree with the voltage noticed at the name plate.**

Switch the power supply on (supply voltage applied to 10 (-) and 11 (+)).

When delivered, the instrument is programmed with a standard configuration (default configuration). According to his measuring task, the customer can change the standard configuration by programming.



**Attention:** When the instrument is built-in a machine and the customer wants to change the configuration, attention must be paid, that no damage will occur to the machine!

## 6. Procedure of programming

The procedure of programming is organized in different steps and can be carried out via the screw terminals 3, 4 and 5 at the rear of the instrument. It is advisable to connect a push button to the screw terminals 3 - 5.

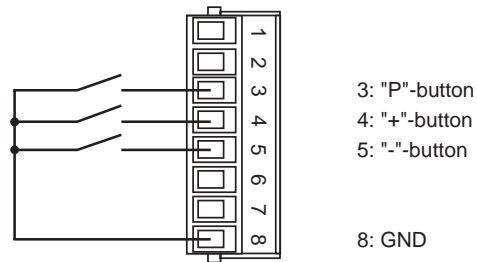

| Push Button                       | Pressing   |
|-----------------------------------|--|
| screw terminal 3<br>"P" - button  | selection of<br>- programming level<br>- parameter                         |
| screw terminal 4<br>"+" - button  | increase of<br>- programming level<br>- number of parameter<br>- parameter |
| screw terminal 5<br>"- " - button | decrease of<br>- programming level<br>- number of parameter<br>- parameter |

### Activating the programming routine

- Press "P"-button together with "+"-button
- The display shows "P-00"

### **Leaving the programming routine**

- Press “+”-button or “-”-button until the display shows “PEnd”
- Confirm the display “PEnd” by pressing “P”-button
- Return to normal measuring

### **Selection of a programming level**

- Selecting a programming level by pressing the “+”-button or “-”-button
- Confirm the selected programming level by pressing the “P”-button
- The display shows the parameter number of the selected programming level  
e.g.: “0-00” => Parameter 0 of programming level 0  
e.g.: ”3-00” => Parameter 0 of programming level 3

### **Leaving a programming level**

- Press “+”-button or “-”-button until the display shows “xEnd”  
e.g.: “0End” => leaving programming level 0  
e.g.: “3End” => leaving programming level 3
- Confirm the display “xEnd” by pressing “P”-button
- The display shows the programming level  
e.g. “P-00” => programming level 0  
e.g. ”P-03” => programming level 3

### **Selection of a parameter**

- Selection the parameter by pressing “+”-button or “-”-button
- Confirm the parameter by pressing “P”-button
- The display shows the last programmed value of the selected parameter

### **Change and confirm a selected parameter**

- Change the parameter by pressing the “+”-button or “-”-button
- Confirm the parameter by pressing “P”-button
- The display shows the programming level and the number of the parameter  
e.g.: “0-05” => Parameter 5 of programming level 0  
e.g.: ”3-03” => Parameter 3 of programming level 3



## **6.1. Summary of the programming level**

The parameters of the panel meter are organized in different programming levels.

### **P-00: Programming level for general configuration of the panel meter**

This level is used to select a measurement mode. General functions like decimal point, display brightness etc. can be also changed in this level.

### **P-03: Programming level for the alarm configuration**

All settings for the alarms can be changed in this programming level.

## 6.2. Programming level for configuration P-00

| Param. | Description   | Range  | Default Value |
|--------|---|--------|---------------|
| 0-00   | Selection of modes<br>0 -> Chronometer / stop watch<br>1 -> Pulse counter forward<br>2 -> Pulse counter backward<br>3 -> Period length measurement<br>4 -> Pulse duration measurement<br>5 -> Frequency measurement<br>6 -> Revolutions per minute<br>7 -> Operating hours meter<br>8 -> Speed in m/s<br>9 -> Speed in km/h | 0 .. 9 | 0             |
| 0-01   | <b>Measuring range selection:</b><br>Function at <b>chronometer / stop watch</b> and <b>period length / pulse duration measurement</b><br>0 -> Automatic measurement range<br>1 -> Resolution 0,01 Sec.<br>2 -> Resolution 0,1 Sec.   | 0 .. 2 | 0             |
|        | Function at <b>pulse counter forward</b><br>0 -> Counter with 5 digits (XXX.X -> XXXX)<br>1 -> Counter with 5 digits (last digit "1")<br>2 -> Counter with 6 digits (last digit "10")   |        |               |
|        | Function at <b>pulse counter backward</b><br>0 -> counter with 5 digits (XXXX.X)<br>1 -> counter with 5 digits (last digit "1")<br>2 -> counter with 5 digits (last digit "10")   |        |               |

## 6. Procedure of programming

| Param. | Description  | Range           | Default Value |        |
|--------|--|-----------------|---------------|--------|
| 0-01   | <b>Measuring range selection: (cont.)</b>  | 0 .. 3          | 0             |        |
|        | Function at <b>frequency measurement</b><br>0 -> Automatic measurement range<br>(fin 0,600 Hz ... 9999 Hz)<br>1 -> Resolution 1 Hz<br>(fin 1 Hz ... 9999 Hz)<br>2 -> Resolution 0,1 Hz<br>(fin 0,1 Hz ... 999,9 Hz)<br>3 -> Resolution 0,01 Hz<br>(fin 0,01 Hz ... 99,99 Hz) |                 |               |        |
|        | Function at <b>revolutions / min.</b><br>0 -> Automatic measurement range<br>1 -> Resolution 1 rpm<br>2 -> Resolution 0,1 rpm<br>3 -> Resolution 0,01 rpm  |                 |               |        |
|        | Function at <b>operating hours meter</b><br>0 -> Automatic measurement range<br>1 -> Resolution 0,01 h<br>2 -> Resolution 0,1 h  |                 |               | 0 .. 2 |
|        | Function at <b>speed with m/s</b><br>0 -> Distance = 1 m<br>Resolution = 0,01 m/s<br>1 -> Distance = var. (P 0-07)<br>Resolution = 0,01 m/s  |                 |               | 0 .. 1 |
|        | Function at <b>speed with km/h</b><br>0 -> Distance = 1 m<br>Resolution = 0,1 km/h<br>1 -> Distance = var. (P 0-07)<br>Resolution = 0,1 km/h   |                 |               | 0 .. 1 |
| 0-02   | Offset at pulse counter f / b  | -9999 .. +99999 | 0             |        |
| 0-03   | Brightness of the display<br>0 -> Brightness 50 %<br>1 -> Brightness 100 %   | 0 .. 1          | 1             |        |

## 6. Procedure of programming

| Param. | Description   | Range          | Default Value |
|--------|---|----------------|---------------|
| 0-04   | Decimal point ( <b>not at automatic measurement range</b> )<br>0 -> XXXXX<br>1 -> XXXX.X<br>2 -> XXX.XX<br>3 -> XX.XXX<br>4 -> X.XXXX   | 0 .. 4         | 0             |
| 0-05   | <b>Operating hours meter:</b><br>0 -> Operating hours meter active after power supply connection.<br>1 -> Operating hours meter active after power supply connection <b>and</b> activation of enable input.                             | 0 .. 1         | 0             |
| 0-06   | Reserve: no function  | -              | -             |
| 0-07   | <b>Scale factor / distance:</b><br>Function at <b>pulse counter</b><br>Adjustable scale factor  | 0.001 - 10.000 | 1.000         |
|        | Function at <b>frequency measurement</b><br>Adjustable scale factor   |                |               |
|        | Function at <b>revolutions / min.</b><br>Adjustable scale factor  |                |               |
|        | Function at <b>speed with m/s a. km/h</b><br>Adjustable distance in meter   | 0.001 - 10.000 | 1.000         |
| 0-08   | Configuration of digit 1 (only at following modes: <b>frequency measurement</b> and <b>revolutions / min</b> )<br>0 -> Display in steps of 1<br>1 -> Display in steps of 2<br>2 -> Display in steps of 5<br>3 -> Display in steps of 10 | 0 .. 3         | 0             |
| 0-09   | Input filter for pulse counter<br>0 -> max. count frequency 7 kHz<br>1 -> max. count frequency 15 Hz  | 0 .. 1         | 0             |
| 0End   | Leaving programming level P-00  |                |               |

### 6.3. Programming level of alarms P-03

| Param. | Description   | Range          | Default Value |
|--------|---|----------------|---------------|
| 3-00   | Configuration of alarm 1<br>0 -> alarm 1 off<br>1 -> contact closed by high limit<br>2 -> contact closed by low limit | 0 .. 2         | 0             |
| 3-01   | Alarm 1, alarm value  | -9999 .. 99999 | 0             |
| 3-02   | Alarm 1, hysteresis   | 0 .. 99        | 0             |
| 3-03   | Reserve: no function  |                | 0             |
| 3-04   | Reserve: no function  |                | 0             |
| 3-05   | Reserve: no function  |                | 0             |
| 3-06   | Reserve: no function  |                |               |
| 3-07   | Reserve: no function  |                |               |
| 3-08   | Reserve: no function  |                |               |
| 3-09   | Reserve: no function  |                |               |
| 3End   | Leaving programming level P-03  |                |               |



The instrument provides two LED. This LED are used to display the state of the alarm values. If alarm 1 is active, the upper LED will light. If alarm 2 is active, the lower LED will light.

**The activation of the auto ranging function (parameter 0-01), will deactivate the alarm functions.**

### 6.3.1. Alarm high setpoint

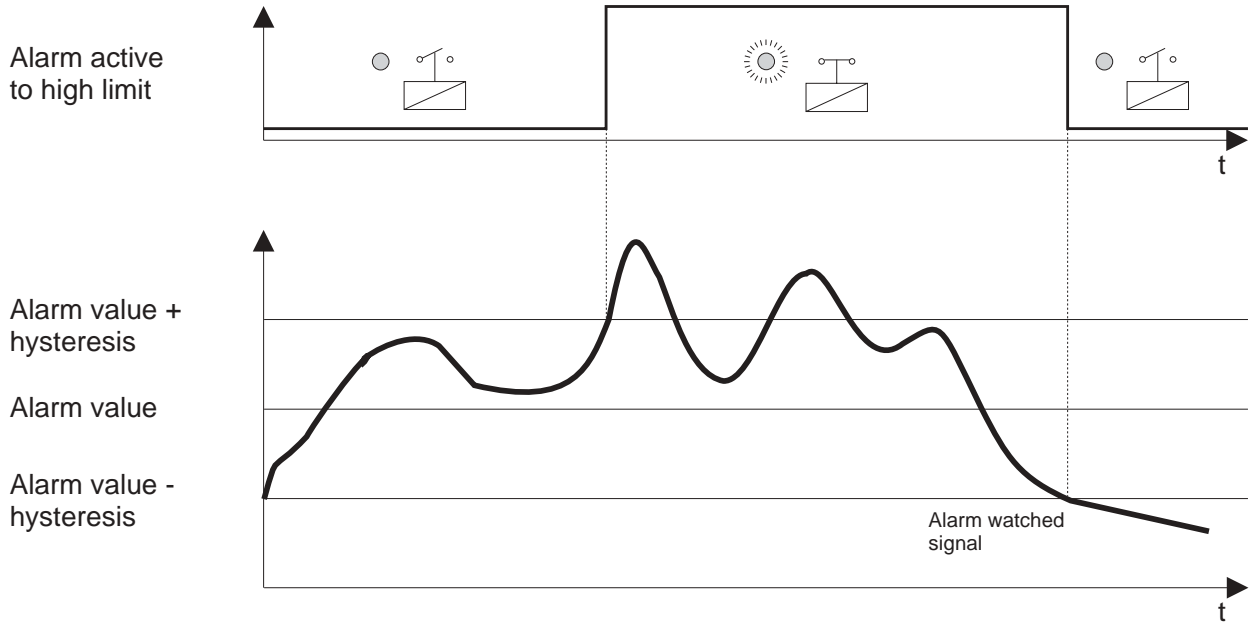

### 6.3.2. Alarm low setpoint

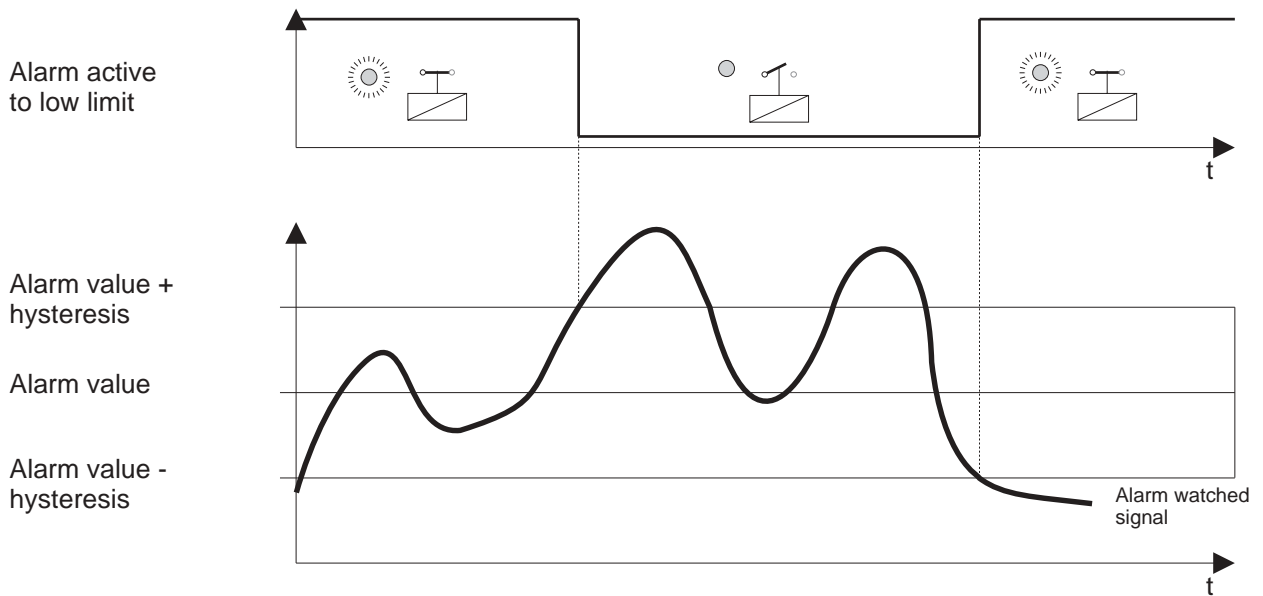

### 6.4. Programming quick reference

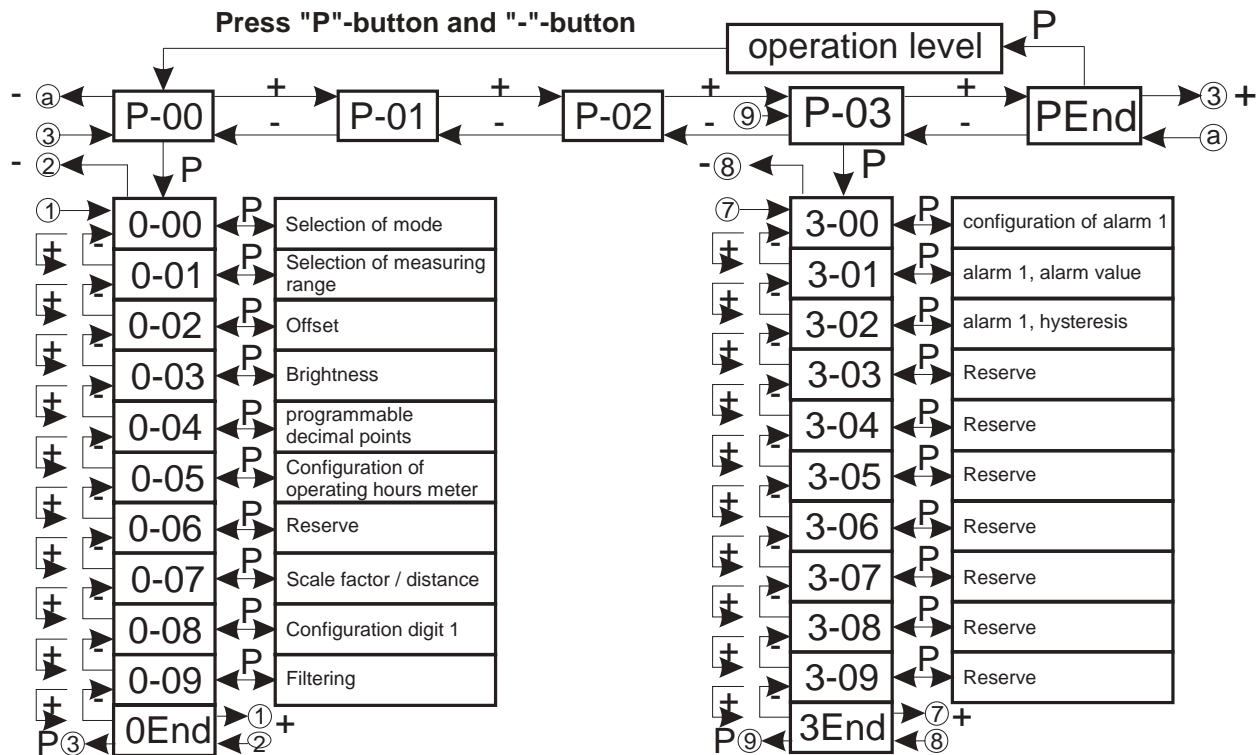

| Description                                |
|--|
| P ≡ pressing "P"-button (screw terminal 3) |
| + ≡ pressing "+"-button (screw terminal 4) |
| - ≡ pressing "-"-button (screw terminal 5) |

## 7. Review of modes

### 7.1. Chronometer / stop watch

In the mode chronometer / stop watch (parameter 0-00 = 0) will the time between a start- and a stop pulse be displayed.

#### Starting chronometer respectively stop watch

- By activating the digital input 3, connecting screw terminal 5 and 8

#### Stopping chronometer respectively stop watch

- By activating the digital input 2, connecting screw terminal 4 and 8

#### Resetting the display

- By activating the digital input 4, connecting screw terminal 6 and 8

The resolution can be set in the parameter 0-01.

### 7.2. Pulse counter forward

In the mode pulse counter forward (parameter 0-00 = 1) will the number of pulses with rising edges be counted:

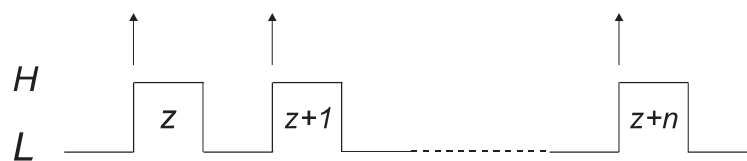

There is the possibility to select an offset-value (parameter 0-02) and a scaling factor (Parameter 0-07). These values will be automatically calculated with the measurement signal and indicated at the display.

#### Connection of signal

- Connecting pulse signal to screw terminal 7 (+) and 8 (-).



### Gate input

- By activating digital input 2, connecting screw terminal 4 and 8

### Switching of counter direction

- By activating digital input 3, connecting screw terminal 5 and 8

### Resetting the counter display

- By activating digital input 4, connecting screw terminal 6 and 8

The number of digits can be set in parameter 0-01

- P 0-01 →0: automatically switch-over between last digit value from 1 to 10.
- P 0-01 →1: counter with 5 digits, last digit = "1"
- P 0-01 →2: counter with 5 digits, last digit = "10"

## 7.3. *Pulse counter backward*

In the mode pulse counter forward (parameter 0-00 = 2) will the number of pulses with rising edges be counted:

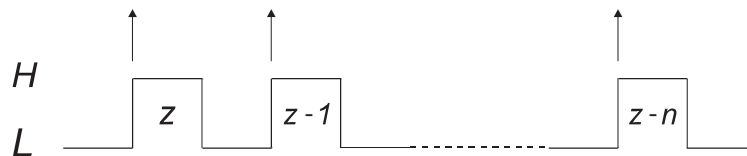

There is the possibility to select an offset-value (parameter 0-02) and a scaling factor (Parameter 0-07). These values will be automatically calculated with the measurement signal and indicated at the display.

### Connection of signal

- Connecting pulse signal to screw terminal 7 (+) and 8 (-).

### Gate input

- By activating digital input 2, connecting screw terminal 4 and 8

### Switching of counter direction

- By activating digital input 3, connecting screw terminal 5 and 8

### Resetting the counter display

- By activating digital input 4, connecting screw terminal 6 and 8

The number of digits can be set in parameter 0-01

- P 0-01 →0: counter with 5 digits, last digit = "1"
- P 0-01 →1: counter with 5 digits, last digit = "1"
- P 0-01 →2: counter with 5 digits, last digit = "10"

## 7.4. *Period length measurement*

In the mode period length measurement (parameter 0-00 = 3) will the time between two rising edges be measured:

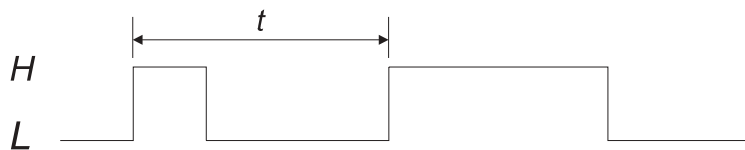

### Connecting of signal

- Connecting pulse signal to screw terminal 7 (+) and 8 (-).

### Resetting the display

- By activating digital input 4, connecting screw terminal 6 and 8

The resolution can be set in the parameter 0-01.



There will be only one period length measured per cycle. Each measurement cycle must be restart by activating digital input 4.

### 7.5. Pulse duration measurement

In the mode pulse duration measurement (parameter 0-00 = 4) will the time between a rising edge and a negative edge be measured:

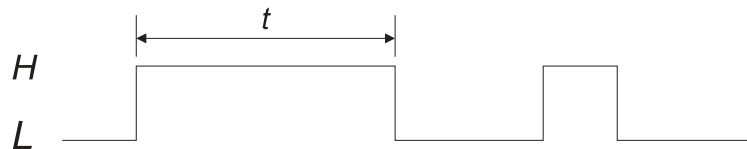

#### Connection of signal

- Connecting pulse signal to screw terminal 7 (+) and 8 (-).

#### Resetting the counter display

- By activating digital input 4, connecting screw terminal 6 and 8

The resolution can be set in the parameter 0-01.



There will be only one pulse duration measured per cycle. Each measurement cycle must be restart by activating digital input 4.

### 7.6. Frequency measurement

In the mode frequency measurement (parameter 0-00 = 5) will a applied frequency be measured:

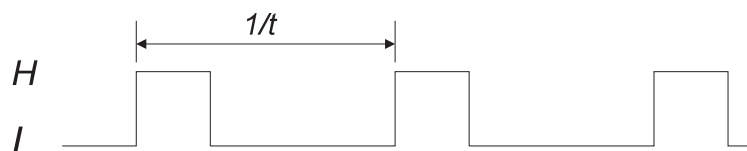

#### Connection of signal

- Connecting a frequency signal to screw terminal 7 (+) and 8 (-).

The measurement range can be set in the parameter 0-01. There is the possibility to select a scaling factor (Parameter 0-07). **Attention:** If the function of automatically measurement range was selected in parameter 0-01, the scaling factor will be deactivated.

### 7.7. *Revolutions per minute*

The number of clock pulses per minute will be measured in the mode revolutions per minute (parameter 0-00 = 6) .

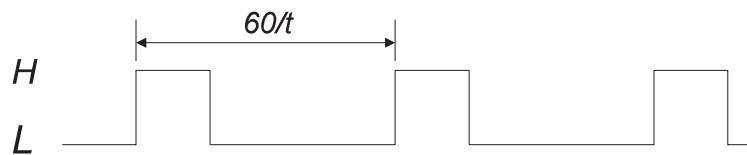

#### Connection of signal

- Connecting pulse signal to screw terminal 7 (+) and 8 (-).

The measurement range can be set in the parameter 0-01. There is the possibility to select a scaling factor (Parameter 0-07). **Attention:** If the function of automatically measurement range was selected in parameter 0-01, the scaling factor will be deactivated.

### 7.8. *Operation hours meter*

The operation hours meter is activated by programming the parameter 0-00 to 7. An enable input can be activated by using parameter 0-05.

#### Starting the operation hours meter without enable input (param. 0-05 to 0)

- Connecting the instrument to supply voltage
- Leaving the programming mode

#### Starting the operation hours meter with enable input (param. 0-05 to 1)

- Applying an active level between 3,5V and 30V to the enable input.

### Resetting of the operation hours meter

- Activating digital input 4, connecting screw terminal 6 and 8
- Leaving the programming mode

The measurement range can be set in the parameter 0-01.

## **7.9. Speed indicator with m/s**

The mode speed indicator with m/s can be activated by programming parameter 0-00 to 8. Dependence on the duration between a start and a stop pulse and a programmed distance (fix. or var.) the speed in m/s will be displayed.

### Starting the speed indicator

- By activating digital input 3, connecting screw terminal 5 and 8

### Stopping the speed indicator

- By activating digital input 2, connecting screw terminal 4 and 8

### Resetting the display

- By activating digital input 4, connecting screw terminal 6 and 8

The distance in meters can be set by programming the parameters 0-01 and 0-07.

| Parameter 0-01 | Parameter 0-07 | Distance in m  |
|----------------|----------------|----------------|
| 0              | XXXX           | 1.000          |
| 1              | 0.001 - 10.000 | 0.001 - 10.000 |

## **7.10. Speed indicator with km/h**

The mode speed indicator with km/h can be activated by programming parameter 0-00 to 9. Dependence on the duration between a start and a stop pulse and a programmed distance (fix. or var.) the speed in km/h will be displayed.

### Starting the speed indicator

- By activating digital input 3, connecting screw terminal 5 and 8

### Stopping the speed indicator

- By activating digital input 2, connecting screw terminal 4 and 8

### Resetting the display

- By activating digital input 4, connecting screw terminal 6 and 8

The distance in meters can be set by programming the parameters 0-01 and 0-07.

| Parameter 0-01 | Parameter 0-07 | Distance in m  |
|----------------|----------------|----------------|
| 0              | XXXX           | 1.000          |
| 1              | 0.001 - 10.000 | 0.001 - 10.000 |

## 8. *Software functions*

### 8.1. *Filtering for pulse counter modes*

There is a digital filter for the modes pulse counter forward/backward available. After the activation of the filter, pulses greater than 15 Hz won't be counted.

#### Activating the filter

- By programming Parameter 0-09 to 1

### 8.2. *Exceeding of the measuring range*

The exceeding of the measuring range will be displayed:

- When **overflow** is active the display shows “nnnnn”
- When **underflow** is active the display shows “uuuuu”

### **8.3. *Display test***

When activating the display test all segments and the alarm LED's of the display are light on. The display shows “:8.8.8.8.8.”

#### **Activating the display test:**

By activating the digital input 1, connecting screw terminal 3 and 8

## 9. *Technical Specifications*

### Measuring modes

#### Chronometer

|                 |                                   |
|-----------------|-----------------------------------|
| Measuring range | :10 ms - 9999,9 s                 |
| Accuracy        | :< 0,1% of display, $\pm$ 1 Digit |

#### Pulse counter

|                |             |
|----------------|-------------|
| max. frequency | :7 kHz/15Hz |
|----------------|-------------|

#### Pulse duration

|                 |                                   |
|-----------------|-----------------------------------|
| Measuring range | :0,01 s - 9999,9 s                |
| Accuracy        | :< 0,1% of display, $\pm$ 1 Digit |

#### Period length

|                 |                                   |
|-----------------|-----------------------------------|
| Measuring range | :0,01 s - 9999,9 s                |
| Accuracy        | :< 0,1% of display, $\pm$ 1 Digit |

#### Frequency

|                 |                                    |
|-----------------|------------------------------------|
| Measuring range | :0,600 Hz - 9,999 kHz              |
| Conversion rate | : 2 measurements/s                 |
| Accuracy        | :< 0,02% of display, $\pm$ 1 Digit |

#### Revolutions/min

|                 |                                   |
|-----------------|-----------------------------------|
| Measuring range | :42,00 rpm - 9999 rpm             |
| Conversion rate | :2 measurements/s                 |
| Accuracy        | :< 0,02% of display $\pm$ 1 Digit |

#### Operating hours meter

|                 |                    |
|-----------------|--------------------|
| Measuring range | :0,02 h - 9999,9 h |
| Accuracy        | :< 0,1% of display |

#### Speed indicator with m/s

|                 |                                     |
|-----------------|-------------------------------------|
| Measuring range | :d = 1 m - 10 m<br>t = 0,1 s - 10 s |
| Accuracy        | :< 0,1% of display $\pm$ 1 Digit    |

#### Speed indicator with km/h

|                 |                                     |
|-----------------|-------------------------------------|
| Measuring range | : d = 1m - 10 m<br>t = 0,1 s - 10 s |
| Accuracy        | :< 0,1% of display $\pm$ 1 Digit    |

### Screw terminals 3 - 6

|           |                          |
|-----------|--------------------------|
| Impedance | : Pull-Up, 10 k $\Omega$ |
| L-level   | : < 0,4 V                |
| H-level   | : > 3,5 V, max. 30 V     |

### Screw terminal 7

|                 |                            |
|-----------------|----------------------------|
| Impedance       | : Pull-Down, 10 k $\Omega$ |
| Switching level | : 2,5V                     |
| max. level      | : 30 V                     |



## 9. Technical Specifications

---

### **Alarm**

Optocoupler output : max. 10 mA, 70 V, max. 150 mW

### **Display**

: 5 decades, 14 mm

Option

: green color

### **Power supply**

: 18 bis 36 V DC (isolated)

Power consumption

: max. 65 mA (red display)

Power consumption

: max. 75 mA (green display)

Optional

: 12 V DC,  $\pm 10\%$  (isolated)

: 5 V DC,  $\pm 10\%$  (isolated)

### **Case**

: 96 x 48 x 63,5 mm

Depth

: < 72 mm (incl. plug-in screw term.)

Protection case, at the front

: IP 40

Protection case, connections

: IP 20

### **EMC**

: in conform with 89/336/EWG

### **Operating temperature**

: 0 bis 50 °C

## 10. Ordering information

| CF 3011 - |  |  |  |  |  |
|-----------|--|--|--|--|--|
|           |  |  |  |  | <b>Case</b>                                  |
|           |  |  |  |  | <b>0</b> Panel mounting                      |
|           |  |  |  |  | <b>1</b> Panel-clip                          |
|           |  |  |  |  | <b>Front becel color</b>                     |
|           |  |  |  |  | <b>0</b> Black                               |
|           |  |  |  |  | <b>Front design</b>                          |
|           |  |  |  |  | <b>0</b> Without front foil                  |
|           |  |  |  |  | <b>1</b> With front foil ERMA-METER          |
|           |  |  |  |  | <b>2</b> With front foil, without ERMA-METER |
|           |  |  |  |  | <b>Display color</b>                         |
|           |  |  |  |  | <b>0</b> Red                                 |
|           |  |  |  |  | <b>1</b> Green                               |
|           |  |  |  |  | <b>Power supply</b>                          |
|           |  |  |  |  | <b>0</b> 5 V DC, ± 10 % (isolated)           |
|           |  |  |  |  | <b>1</b> 12 V DC, ± 10 % (isolated)          |
|           |  |  |  |  | <b>2</b> 18 .. 36 V DC (isolated)            |



ERMA - Electronic GmbH  
Max-Eyth-Straße 8  
D-78194 Immendingen

Telefon (+49 7462) 7381  
Fax (+49 7462) 7554  
email [erma-electronic@t-online.de](mailto:erma-electronic@t-online.de)  
Web [www.erma-electronic.de](http://www.erma-electronic.de)

**ERMA**

Electronic GmbH