DM 3002 Panel Meter

for Strain Gauge Bridge Sensors (DMS)

Instruction Manual



ERMA

Electronic GmbH

Warranty

For delivered products our "Allgemeine Lieferungs- und Zahlungsbedingungen" are effective. In no event ERMA-Electronic or its suppliers shall be liable for any other damages whatsoever (including, without limitation, damages for loss of business profits, business interruption or other pecuniary loss) arising out of or inability to use this product.

All products from ERMA-Electronic are warranted against defective material and workmanship for a period of two (2) years from date of delivery. If it is necessary to return the product to ERMA, the sender is responsible for shipping charges, freight, insurance and proper packaging to prevent breakage in transit. ERMA's warranty does not apply to defects resulting from action of the buyer, such mishandling, improper interfacing, operation outside of design limits, improper repair or unauthorized modification.

Trademarks

All trademarks they are named or portrayed in the text are registered trademarks of its owner. The trademarks are recognized by ERMA-Electronic.

CONTENTS

1. Description	4
2. Safety instructions	5
2.1. Explanation of symbols	5
3. Mounting	6
3.1. Place of operation	6
3.2. Mounting of digital panel meter	6
3.2.1.Housing for switch board	6
3.2.2.Housing for mosaic systems	7
4. Electrical Connections	8
4.1. General instruction	8
4.2. Hints against noisy environment	8
4.3. Connection and pin assignment	9
4.4. Connection of strain gauge bridge sensor	10
4.5. Connection of digital user inputs	10
4.6. Connection of alarm outputs (relay)	10
4.7. Connection of accessory power supply output	10
4.8. Connection of analog output	11
4.9. Connection of RS 485 interface	11
4.10. Connection of RS 232 interface	11
4.11. Connection of Current-Loop interface	11
4.12. Connection of power supply	12
4.12.1.Supply voltage 95 ... 250 V AC	12
4.12.2.Supply voltage 18 ... 36 V DC	12
5. Startup procedure	12
6. Service instruction	13
6.1. Function of buttons and LEDs	13
7. Modes	14
7.1. Operation level	14
7.2. Access-code level	15
7.3. Programming level	16
8. Procedure of programming	17

8.1.	Changing or controlling of the parameters	17
8.2.	Overview of the programming levels	18
8.3.	Programming for configuration P-00	19
	8.3.1. Scaling the display range	22
8.4.	Programming level of linearization P-01	24
	8.4.1. 10-point-linearization	25
8.5.	Programming level of alarm outputs P-02	26
	8.5.1. Alarm output functions	27
	8.5.2. Alarm high setpoint	29
	8.5.3. Alarm low setpoint	29
8.6.	Programming level of analog output P-03	30
	8.6.1. Scaling of the analog output	30
	8.6.2. Analog output at failure indication	31
8.7.	Programming level of serial interface P-04	32
	8.7.1. Transfer-Mode	33
	8.7.2. Overview of serial interfaces	33
8.8.	Programming quick reference	34
9.	Software functionsn	36
9.1.	MIN/MAX value detection	36
9.2.	Averaging	36
9.3.	Taring	37
9.4.	Display hold	37
9.5.	Display test	38
9.6.	Main reset	38
10.	Technical Specifications	39
10.1.	Electrical datas	39
10.2.	Mechanical datas	40
10.3.	Environmental conditions	40
11.	Ordering information	41
12.	Notices	41

Stand : 27.11.00
DM3002D.PUB
Technical Subjects To Change

1. Description

The digital panel meter model **DM 3002** is used for analyzing and indication of strainage bridge (DMS). A reference voltage output allows a directly connection of the strainage bridge. Bridges with following output voltages can be connected:

- DMS 1 mV/V
- DMS 1,5 mV/V
- DMS 2 mV/V
- DMS 3 mV/V

Standard hardware components

- Two relay alarm outputs
- Two programmable digital input channels
- Three programmable push buttons

Standard software functions

- Tare function
- Average value function
- 10-point-linearization
- MAX/MIN value detection
- Auto-Reset of MAX/MIN value
- Manual alarm output reset
- Display test and display hold (Latch)

Following options are available

- Analog output 0 - 10 V, 2 - 10 V, 0 - 20 mA, 4 - 20 mA
- RS485 interface
- RS232 interface
- TTY, Current-Loop interface

2. Safety instructions

This instrument is produced in accordance with Class II of IEC 348 and VDE 0411. When delivered the instrument has been tested to meet all functions described. Before installing the instrument please read the mounting and servicing instructions. We have no liability or responsibility to customer or any other person or entity with respect to any liability, loss or damage caused or alleged to be caused directly or indirectly by equipment or software sold or furnished by us. Read the installation instruction carefully. No liability will be assumed for any damage caused by improper installation.

Inspect the instrument module carton for obvious damage. Be shure there are no shipping and handing damages on the module before processing. Do not apply power to the instrument if it has been damaged.

ERMA's warranty does not apply to defects resulting from action of the buyer, such as mishandling, improper interfacing, operation outside of design limits, improper repair or unauthorized modifications.

2.1. Explanation of symbols



Caution



Attention



Instruction



Hint

Caution: Will be used at **dangerous for life and health !**

Attention: Will cause **damage**

Instruction: If not noticed, **trouble** may occur

Tip: Useful hints for **better operation**

3. Mounting

3.1. Place of operation

Attention must be paid to the protection against humidity, dust and high temperatures at the place of operation.

3.2. Mounting of digital panel meter

3.2.1. Housing for switch board

- Insert the case into the panel cutout (according to DIN 43700: $92^{+0,8} \times 45^{+0,6}$ mm)
- Tighten the screws alternately, using enough pressure to get good retention and sealing at the panel.

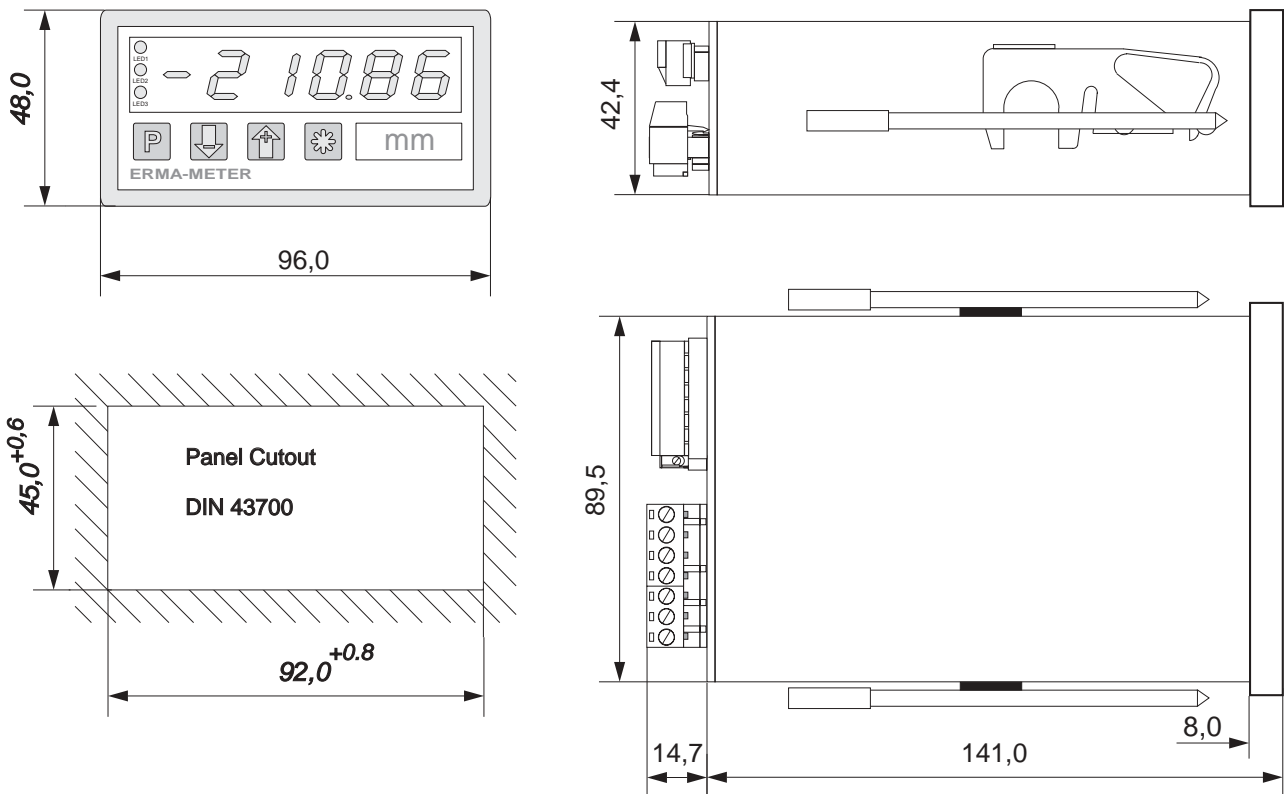

3.2.2. *Housing for mosaic systems*

- Insert the case into one of the following mosaic systems :
 - a) Mosaic system 8RU (M50x25) of Siemens
 - b) Mosaic system of Subklev

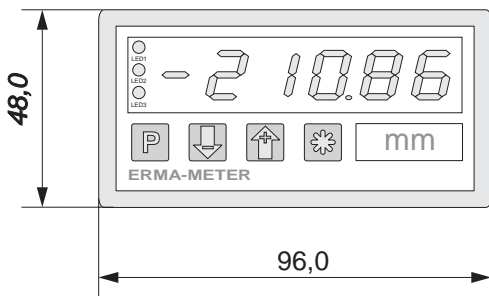

Mosaic Systems:

Siemens 8RU (M50x25)

Subklev

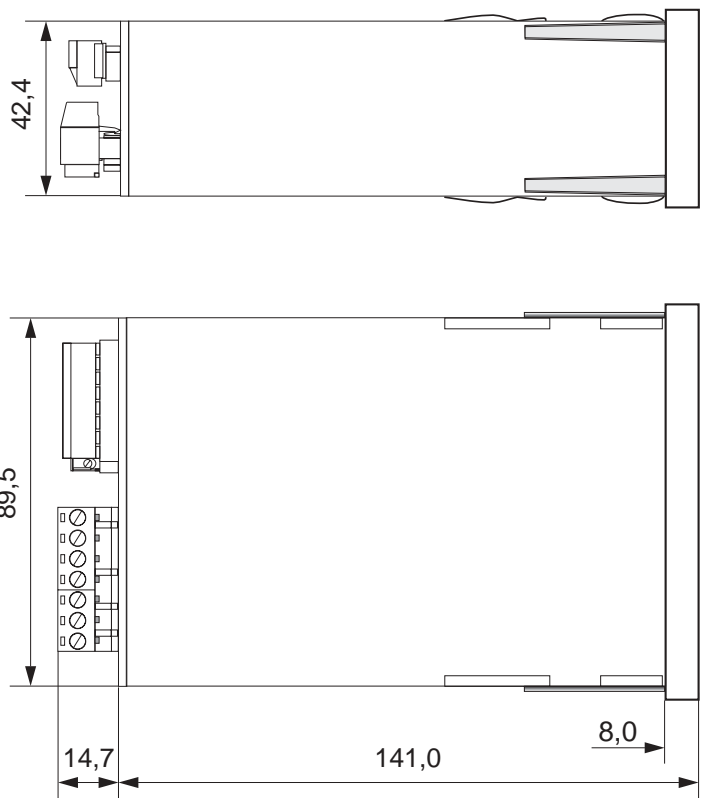

4. **Electrical Connections**

4.1. **General instruction**



- It is forbidden to plug or unplug connectors with voltage applied
- Attach input and output wires to the connectors only without voltages applied
- Cords must be provided with sleeves
- Attention must be paid that the power supply voltage applied will agree with voltage noticed at the name plate.
- The instrument has no power-on switch, so it will be in operation as soon as the power is connected.

4.2. **Hints against noisy environment**

All inputs and outputs are protected against noisy environment and high voltage spikes. Nevertheless the location should be selected to ensure that no capacitive or inductive interference can have an effect on the instrument or the connection lines.

It is advisable:



- To use shielded cables.
- The wiring of shields and ground (0V) should be star-shaped.
- The distance to interference sources should be as long as possible. If necessary, protective screen or metal enclosures must be provided.
- Coils of relays must be supplied with filters.
- Parallel wiring of input signals and AC power lines should be avoided.

4.3. Connection and pin assignment

All inputs and outputs are connectors designed as plug-in screw terminals.

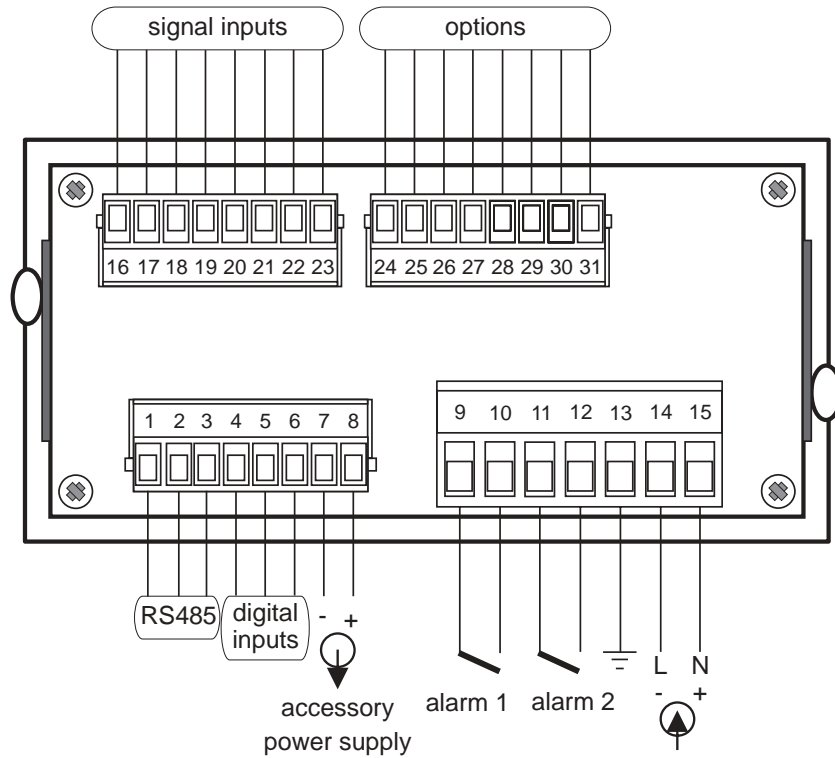

Pin assignment:

1	RS 485, GND	16	Signal input DMS
2	RS 485, B(-)	to	
3	RS 485, A(+)	23	
4	GND of digital inputs	24	Option analog output or option RS 232 interface or option Current-Loop, TTY interface
5	Digital user input 1	to	
6	Digital user input 2	31	
7	Accessory power supply output (-)		
8	Accessory power supply output (+)		
9/10	Alarm (relay) output 1		
11/12	Alarm (relay) output 2		
13	Ground connection		
14	Power supply L, DC (-)		
15	Power supply N, DC (+)		

4.4. Connection of strainage bridge sensor

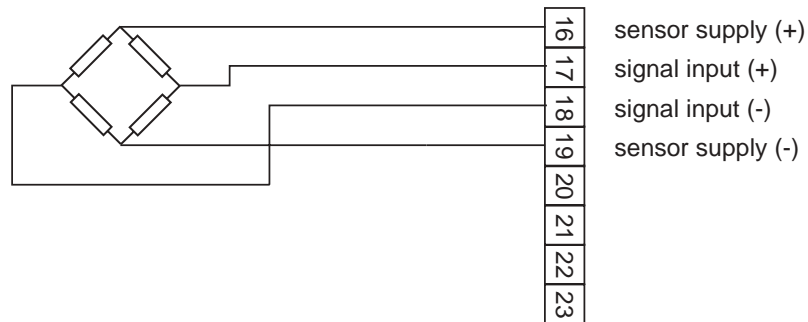

4.5. Connection of digital user inputs

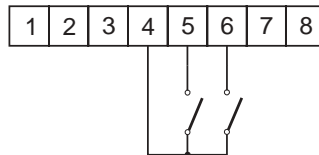

Digital input 1

- active => connecting screw terminal 4 to 5
- connecting to ground, low active

Digital input 2

- active => connecting screw terminal 4 to 6
- connecting to ground, low active

4.6. Connection of alarm outputs (relay)

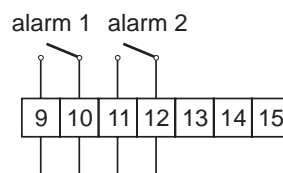

4.7. Connection of accessory power supply output

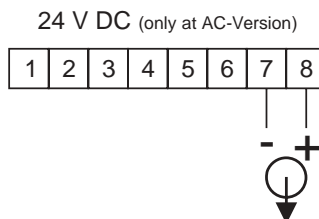

4.8. Connection of analog output

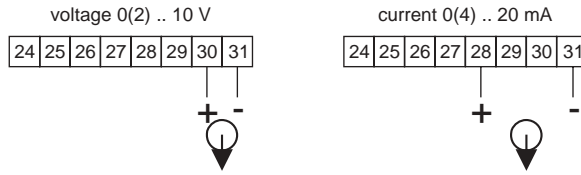

4.9. Connection of RS 485 interface

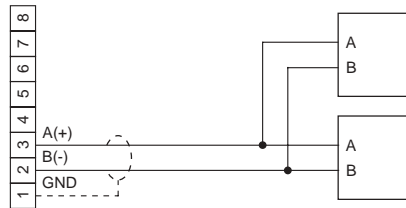

4.10. Connection of RS 232 interface

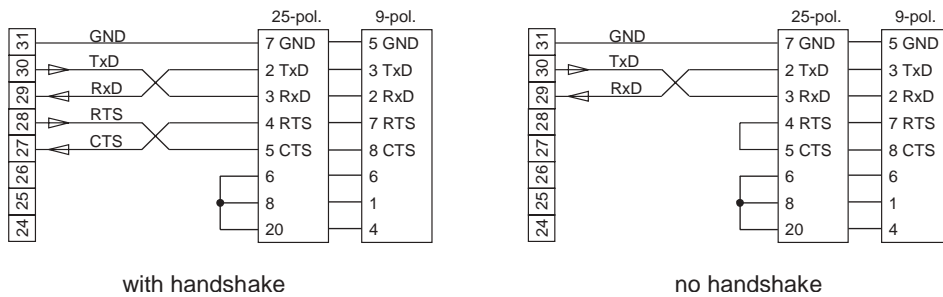

4.11. Connection of Current-Loop interface

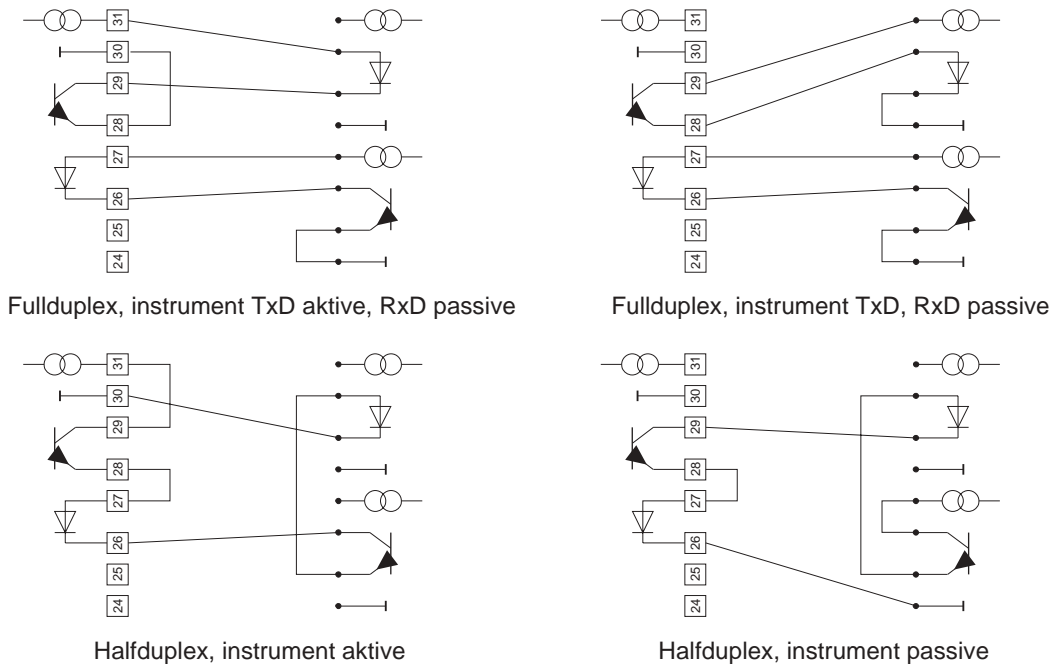

4.12. Connection of power supply

4.12.1. Supply voltage 95 ... 250 V AC

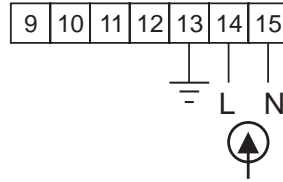

4.12.2. Supply voltage 18 ... 36 V DC

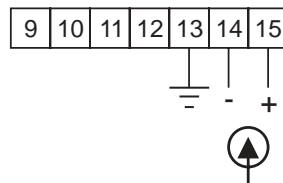

5. Startup procedure

Attention must be paid that the power supply voltage applied will agree with the voltage noticed at the name plate.



Switch the power supply on (supply voltage applied to 14 and 15). After about 2 seconds the display will indicate the applied input signal.

When delivered, the instrument is programmed with a standard configuration (default configuration). By programming the customer can change the standard configuration according to his measuring task.



Attention: When the instrument is built in a machine and the customer wants to change the configuration, attention must be paid, that no damage will occur to the machine!

6. Service instruction

There are four push buttons in the front. These push buttons can have different functions. The functions of the push buttons are determined by the used mode of the instrument. By this way the push buttons can be used for programming and for service.

6.1. Function of buttons and LEDs

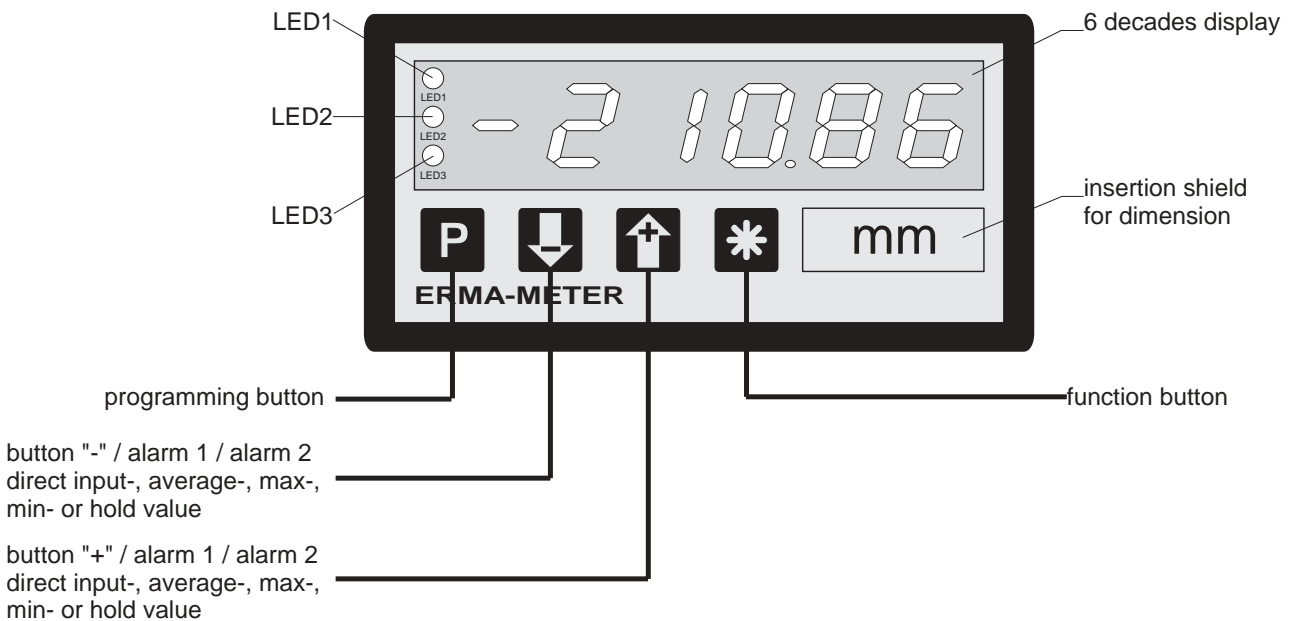

LED 1	LED 2	LED 3	Description
x	x	off	measured-, average- or hold value
x	x	red	MIN value is displayed
x	x	green	MAX value is displayed
x	x	green/blinks	Programming mode is active
x	off	x	alarm 2 is not active
x	lights	x	alarm 2 is active
x	blinks	off	alarm point 2 is displayed
x	blinks	green/blinks	alarm point 2 is changing
off	x	x	alarm 1 is not active
lights	x	x	alarm 1 is active
blinks	x	off	alarm point 1 is displayed
blinks	x	green/blinks	alarm point 1 is changing

x = state of the LED is not important

7. Modes



The operation and the programming of the panel meter is organized in several states:

- Operation level
- Access-code level
- Programm level

7.1. Operation level

In the state “operation level” the normal functions of the instrument are activated. A normal measurement cycle looks like below:

- Read measured value, linearization and displaying
- Evaluate the digital user inputs
- Alarm outputs, or analog output resp. data transfer

Dependent on the programming of the parameter **0-13** (function of key ) , **0-14** (function of key ) and **0-12** (function of key ) , following key-functions are available in the operation level.

Parameter 0-12 Function of pushbutton “*”	 By pressing
0	No function
1	Reset the MIN/MAX value
2	Taring
3	Clear tara value
4	Manual reset of alarms
5	Manual data transfer





Parameter 0-13 Function of pushbutton “-”		
	By pressing	Pressing during 3 sec.
0	No function	-
1	Display measuredvalue	-
2	Display average value	-
3	Display MAX value	-
4	Display MIN value	-
5	Display hold value	-
6	Display alarm point 1	Change alarm point 1
7	Display alarm point 2	Change alarm point 2

7. Modes

Parameter 0-14 Function of pushbutton “+”		
	By pressing	Pressing during 3 sec.
0	No function	-
1	Display measured value	-
2	Display average value	-
3	Display MAX value	-
4	Display MIN value	-
5	Display hold value	-
6	Display alarm point 1	Change alarm point 1
7	Display alarm point 2	Change alarm point 2

7.2. Access-code level

The state “access-code level” becomes active by pressing the pushbutton  during the state “operation level”. The display shows “c000”. During the state “access-code level” the normal functions of the instrument are active.





pushbutton	Function
	Confirm of the displayed access-code
	Increase the access-code
	Decrease the access-code
	Programmed function

7.3. Programming level

The state “programming level” becomes active by entering the right access-code.

The access-code must be confirm by pressing the pushbutton . The programming is organized in following steps:



- Selection of a programming level
- Selection of a parameter
- Change of the selected parameter

Pushbutton	Press	Pressing during 3 sec.
	Selection of - Programm level - Parameter	-
	Decrease of - Programm level - Number of parameter - Value of parameter	-
	Increase of - Programm level - Number of parameter - Value of parameter	-
	-	Break the programming routine

8. Procedure of programming

The procedure of programming is organized in several different steps.



Access to the selection of the programming levels

- Pressing pushbutton **P** => access-code enter is active
- The display shows "c000"
- Changing the access-code by pressing the pushbutton  or  and confirm the changed access-code by pressing the pushbutton **P**



If the entered access-code is not correct, the instrument will jump back to the state "operation level".

8.1. Changing or controlling of the parameters



Activating the programming routine

- Pressing pushbutton **P**
- LED 3 flashes green
- The display shows "c000"
- Changing the access-code by pressing the pushbutton  or 
- Confirm access-code by pressing the pushbutton **P**
- The display shows "P-00"



Leaving the programming routine

- Pressing the pushbutton  or  until the display shows "PEnd"
- Confirm the display "PEnd" by pressing the pushbutton **P**
- LED 3 is off
- The active state of the panel meter is "operation level"



Selection of the programming level

- Selecting the programming level by pressing the pushbutton  or 
- Confirm the programming level by pressing the pushbutton **P**
- The display shows the number of the parameter of the selected programming level
For example: "0-00" => parameter 0 of the programming level 0
For example: "1-00" => parameter 0 of the programming level 1



Leaving the programming level

- Pressing the pushbutton  or  until the display shows "xEnd"
For example: "0End" => leaving programming level 0
For example: "1End" => leaving programming level 1
- Confirm the display "xEnd" by pressing the pushbutton 
- The display shows the programming level
For example: "P-00" => for programming level 0
For example: "P-01" => for programming level 1

Selection of the parameter

- Selection the parameter by pressing the pushbutton  or 
- Confirm the parameter by pressing the pushbutton 
- The display shows the last programmed value of the selected parameter

Change and controll the selected parameter

- Change the value of the parameter by pressing the pushbutton  or 
- Confirm the value of the parameter by pressing the pushbutton 
- The display shows the programming level and the number of the parameter
For example: "0-05" => parameter number 5 of programming level 0
For example: "1-08" => parameter number 8 of programming level 1

8.2. Overview of the programming levels

The parameters of the panel meter are organized in different programming levels. According to the execution of the panel meter there are several programming levels available.

P-00: Programming level to configuration the panel meter

The configuration is used to adapt the strain gauge bridge sensor to the panel meter.

P-01: Programming level of 10 point linearization

This programming level is used to program the values for the linearization.

P-02: Programming level of alarm output function

This programming level is used to program all settings of the alarm outputs.

P-03: Programming level of the analog output

This programming level is used to program all settings of the analog output..

P-04: Programming level of the serial interface

This programming level is used to program the parameters of the serial interface.

8.3. Programming for configuration P-00

Param.	Description	Setting range	Default values
0-00	input range 0 -> DMS 1 mV/V 1 -> DMS 1,5 mV/V 2 -> DMS 2 mV/V 3 -> DMS 3 mV/V	0 .. 3	0
0-01	calibration 0 -> without calibrator 1 -> with calibrator	0 .. 1	0
0-02	display value of the minimal input signal	-99999 .. +99999	-10000
0-03	display value of the maximal input signal	-99999 .. +99999	+10000
0-04	Programmable points 0 -> XXXXXX 1 -> XXXXX.X 2 -> XXXX.XX 3 -> XXX.XXX 4 -> XX.XXXX	0 .. 4	0
0-05	averaging 1 -> no averaging X -> number of averaging cycles	1 .. 255	1
0-06	data source of the display 0 -> direct measured value 1 -> average value 2 -> MAX value 3 -> MIN value 4 -> hold value	0 .. 4	0
0-07	data source of maximum, minimum and hold value 0 -> direct measured value 1 -> average value	0 .. 1	0
0-08	configuration of digit 1 0 -> display in steps of 1 1 -> display in steps of 2 2 -> display in steps of 5 3 -> display in steps of 10	0 .. 3	0
0-09	reset time of the MAX/MIN value 0 -> no automatically reset X -> reset time in seconds	0 .. 100	0

8. Procedure of programming

Param.	Description	Setting range	Default values
0-10	function of digital user input 1 0 -> no function 1 -> reset MAX/MIN value 2 -> taring 3 -> clear tara value 4 -> manual reset of alarms 5 -> hold function 6 -> display test 7 -> display direct measured value 8 -> display MAX value 9 -> display MIN value 10 -> manual data transfer	0 .. 10	0
0-11	function of digital user input 2 0 -> no function 1 -> reset MIN/MAX value 2 -> taring 3 -> clear tara value 4 -> manual reset of alarms 5 -> hold function 6 -> display test 7 -> display direct input value 8 -> display MAX value 9 -> display MIN value 10 -> manual data transfer	0 .. 10	0
0-12	function of pushbutton "*" 0 -> no function 1 -> reset MAX/MIN value 2 -> taring 3 -> clear tara value 4 -> manual reset of alarm 5 -> manual data transfer	0 .. 5	0
0-13	function of pushbutton "-" 0 -> no function 1 -> display direct measured value 2 -> display average value 3 -> display MAX value 4 -> display MIN value 5 -> display hold value 6 -> display/change alarm point 1 7 -> display/change alarm point 2	0 .. 7	0

8. Procedure of programming

Param.	Description	Setting range	Default values
0-14	function of pushbutton “-” 0 -> no function 1 -> display direct measured value 2 -> display average value 3 -> display MAX value 4 -> display MIN value 5 -> display hold value 6 -> display/change alarm point 1 7 -> display/change alarm point 2	0 .. 7	0
0-15	access-code	0 .. 999	0
0End	Leaving programming level P-00		

8.3.1. Scaling the display range

The overflow or underflow becomes active if the displayed value is greater or smaller than more as 1 % of the programmed display range (parameter 0-02 and 0-03).

- When **overflow** is activ the display shows “nnnnnn”
- When **underflow** is active the display shows “uuuuuu”



All ranges are calibrated at work. To commissioning the panel meter there is no calibration necessary.

If a new adjustment of input signal to the display range is necessary there are two possibilities to adjust the input signal to the display range:

- Calibration without calibrator
- Calibration with calibrator

Calibration without a calibrator

The assignment of the display range to the minimal and maximal input signal is done by programming the parameter 0-02 and 0-03.

! The parameter 0-01 must be programmed to 0

Example:

Input range: DMS 3 mV/V

Display range: ± 15000

Step	Param.	Setting
1.	0-00	3
2.	0-01	0
3.	0-02	-15000
4.	0-03	15000
5.	0End	return

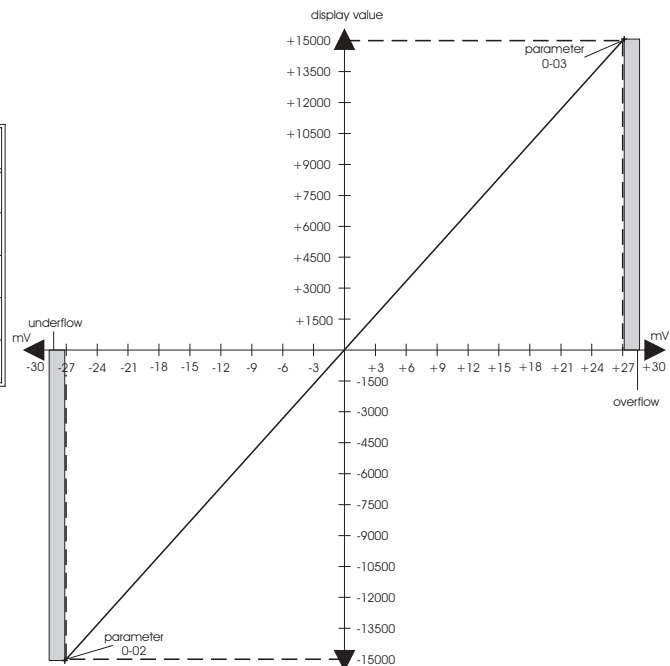

8. Procedure of programming

Calibration with calibrator

The assignment of the display range to the minimal and maximal input signal is done by programming the parameter 0-02 and 0-03. The minimal and maximal input signal must be connected direct to the panel meter when programming the parameter 0-02 or 0-03.

! The parameter 0-01 must be programmed to 1.

! Attention: By the calibration with a calibrator the factory settings of the adjustment values are changed. Make use of this possibility only with a suitable calibrator. The factor settings of the adjustment values are changed as soon as displaying the value of the parameter 0-02 or 0-03.

Example:

Input range: 0 V to + 18 mV

Display range: 0 to + 9000

Step	Param.	Procedure	Setting
1.	0-01	-	1
2.	-	connecting 0 V to the signal input	-
3.	0-02	-	0
4.	-	connecting + 18 mV to the signal input	-
5.	0-03	-	9000
6.	0End	-	return

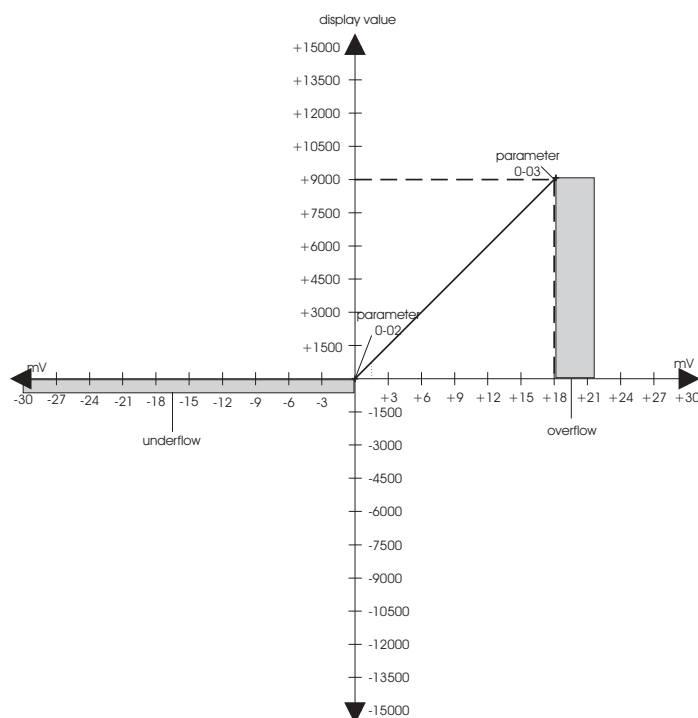

8.4. Programming level of linearization P-01

Param.	Description	Setting range	Default values
1-00	Number of linearization points	2 .. 10	2
1-01	Linearization point 1 Input value	± max. prog. display range	-10000
1-02	Linearization point 1 Output value	± max. prog. display range	-10000
1-03	Linearization point 2 Input value	± max. prog. display range	+10000
1-04	Linearization point 2 Output value	± max. prog. display range	+10000
1-05	Linearization point 3 Input value	± max. prog. display range	0
1-06	Linearization point 3 Output value	± max. prog. display range	0
1-07	Linearization point 4 Input value	± max. prog. display range	0
1-08	Linearization point 4 Output value	± max. prog. display range	0
1-09	Linearization point 5 Input value	± max. prog. display range	0
1-10	Linearization point 5 Output value	± max. prog. display range	0
1-11	Linearization point 6 Input value	± max. prog. display range	0
1-12	Linearization point 6 Output value	± max. prog. display range	0
1-13	Linearization point 7 Input value	± max. prog. display range	0
1-14	Linearization point 7 Output value	± max. prog. display range	0
1-15	Linearization point 8 Input value	± max. prog. display range	0
1-16	Linearization point 8 Output value	± max. prog. display range	0
1-17	Linearization point 9 Input value	± max. prog. display range	0
1-18	Linearization point 9 Output value	± max. prog. display range	0

Param.	Description	Setting range	Default values
1-19	Linearization point 10 Input value	± max. prog. display range	0
1-20	Linearization point 10 Output value	± max. prog. display range	0
1End	Leave programming level P-01		

8.4.1. 10-point-linearization

The panel meter include the possibility of a linearization up to 10 points.

Linearization of the input signal

- only in the programmed display range possible (parameter 0-02 and 0-03)

Performing a linearization

- Insert the number of linearization points (parameter 1-00)
- For each point must be programmed two values, the input value and the corresponding output value
- If leaving the programming routine, the linearization points will sort in rising sequence

Reset the linearization points by

- Changing the parameter 0-02 or 0-03
- Changing the input range (parameter 0-00)

Reset the linearization points to

- Number of linearization points = 2 (parameter 1-00)
- Linearization point 1 = parameter 0-02
- Linearization point 2 = parameter 0-03

8.5. Programming level of alarm outputs P-02

Param.	Description	Setting range	Default values
2-00	Alarm output 1, data source 0 -> Alarm 1 off 1 -> Alarm 1 to direct measured value 2 -> Alarm 1 to average value 3 -> Alarm 1 to maximum value 4 -> Alarm 1 to minimum value 5 -> Alarm 1 to hold value	0 .. 5	0
2-01	Alarm output 1, high or low 0 -> Contact closed by low limit 1 -> Contact closed by high limit 2 -> Contact open by low limit 3 -> Contact open by high limit	0 .. 3	0
2-02	Alarm output 1, alarm point	± max. prog. display range	Param. 0-03
2-03	Alarm output 1, hysteresis	1 .. 1000	1
2-04	Alarm output 1, release delay time in seconds	0 .. 60	0
2-05	Alarm output 1, operate delay time in seconds	0 .. 60	0
2-06	Alarm output 2, data source 0 -> Alarm 2, off 1 -> Alarm 2 to direct measured value 2 -> Alarm 2 to average value 3 -> Alarm 2 to maximum value 4 -> Alarm 2 to minimum value 5 -> Alarm 2 to hold value	0 .. 5	0
2-07	Alarm output 2, high or low 0 -> Contact closed by low limit 1 -> Contact closed by high limit 2 -> Contact open by low limit 3 -> Contact open by high limit	0 .. 3	0
2-08	Alarm output 2, alarm point	± max. prog. display range	Param. 0-03
2-09	Alarm output 2, hysteresis	1 .. 1000	1
2-10	Alarm output 2, release delay time in seconds	0 .. 60	0
2-11	Alarm output 2, operate delay time in seconds	0 .. 60	0
2End	Leave programming level P-02		

8.5.1. Alarm output functions

Data sources of the alarm outputs:

- Direct measured value
- Average value
- Maximum value
- Minimum value
- Hold value

Indication of alarm outputs

- Two relay output
- LED 1 and LED 2 at the front

Reset the alarms points by

- Changing the parameter 0-02 or 0-03
- Changing the input range (parameter 0-00)

Reset the alarms points to default values:

- Alarm point value = parameter 0-03
- The alarms are switched off



Programmable functions of the alarm outputs

- Alarm point value
- Hysteresis
- Release delay time and operate delay time
- High or low alarm

Manual alarm reset

In dependence of programming the digital inputs and the functional pushbutton  is the alarm output latched or not latched.

Alarm output latched:



- If the digital input 1, 2 (parameter 0-10 and 0-11) or the functional pushbutton  (parameter 0-12) is programmed to manual alarm reset
- Reset the latched alarm output by activate the digital inputs or press the functional pushbutton 

Alarm output not latched:

- If the digital inputs and the functional pushbutton  are not programmed to manual alarm reset

Display and edit the alarm point values

The alarm points can displayed and edited on different kinds.

- Inside the programmig routine, which is reached over the enter code. During the programming routine no measurement is taken.
- Outside the programming routine by pressing the pushbutton  or  during normal measurement are taken.

The edition is end when pressing the pushbutton  . Therefore the alarm value will be up to date.

8.5.2. Alarm high setpoint

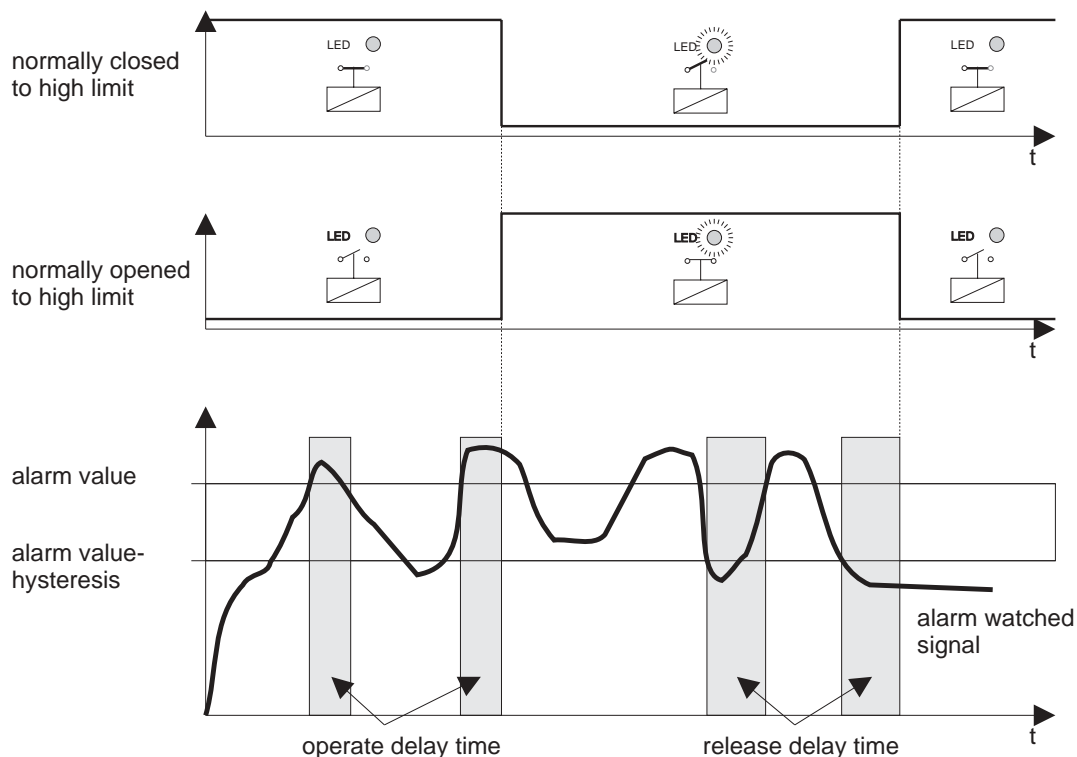

8.5.3. Alarm low setpoint

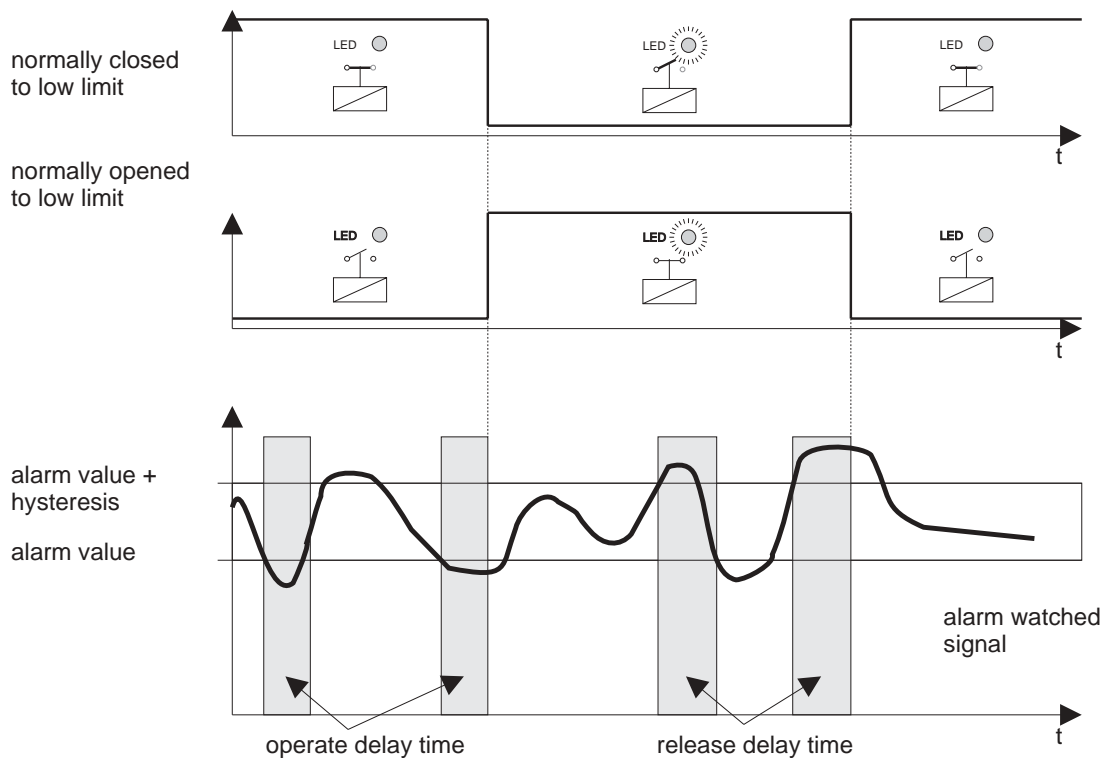

8.6. Programming level of analog output P-03

The parameters of this programming level P-03 exists only by panel meters with the option analog output.

Param.	Description	Setting range	Default values
3-00	Analog output, data source 0 -> Direct measured value to analog output 1 -> Average value to analog output 2 -> Maximum value to analog output 3 -> Minimum value to analog output 4 -> Hold value to analog output	0 .. 4	0
3-01	Analog Output, configuration 0 -> 0 to 10 V 1 -> 2 to 10 V 2 -> 0 to 20 mA 3 -> 4 to 20 mA	0 .. 3	0
3-02	Display value for minimal analog output signal	± max. prog. display range	-10000
3-03	Display value for maximal analog output signal	± max. prog. display range	10000
3End	Leave programming level P-03		

8.6.1. Scaling of the analog output

The scaling of the analog output range can be programmed with the parameter 3-02 and 3-03. Any value in the configured scale (parameter 0-02 and 0-03) can be set to minimal and maximal analog output signal.

Data sources of the analog output:

- Direct measured input
- Average value
- Minimum- or Maximum value
- Hold value

Reset the scaling of the analog output range by:

- Changing the parameter 0-02 or 0-03
- Changing the input range (parameter 0-00)

Reset the scaling of the analog output range to:

- Parameter 3-02 = Parameter 0-02
- Parameter 3-03 = Parameter 0-03

8.6.2. Analog output at failure indication

Analog output signal	Output value by overflow	Output value by underflow
voltage 0 to 10 V	10 V	0 V
voltage 2 to 10 V	10 V	2 V
current 0 to 20 mA	20 mA	0 mA
current 4 to 20 mA	20 mA	4 mA

8.7. Programming level of serial interface P-04

The parameters of this programming level P-04 exists only by panel meters with the option serial interface. The interface modules are bidirectional and isolated of the further electronic.

Param.	Description	Setting range	Default values
4-00	Interface address	0 .. 31	1
4-01	Interface baud rate 0 -> 300 baud 1 -> 600 baud 2 -> 1200 baud 3 -> 2400 baud 4 -> 4800 baud 5 -> 9600 baud 6 -> 19200 aud	0 .. 6	6
4-02	Transfer mode 0 -> PC-Mode 1 -> Terminal-Mode by using the timer register 2 -> Terminal-Mode by manual data transfer	0 .. 2	0
4-03	Timer register (sec) 0 -> Data transfer by conversion rate	0 .. 3600	0
4-04	Data source to transfer 0 -> Measured Value 1 -> Average value 2 -> Maximum value 3 -> Minimum value	0 .. 3	0
4-05	Handshake-Controlling at option RS 232 0 -> No Handshake-Controlling 1 -> Handshake-Controlling	0 .. 1	1
4End	Leav programming level P-04		

The panel meter can be controlled completely with the serial interface. That means the panel meter can be initialized of a host (unit name, revision number). It can be adjusted all parameters and it can be read all measured values resp. all values of the parameters.

8.7.1. Transfer-Mode

PC mode

With PC mode, the PC must send special commands to get a value. The commands set is describe in a separate user manual.

Terminal mode by using the timer register

A transmission can initialise by using the timer register (4-03). You can set the register to 0 sec (transmission by conversion rate) to 3600 sec to get periodical transmission.

Terminal mode by manual data transfer release

A transmission can initialise by using a external contact (0-10 = 10 resp. 0-11 = 10) or by using the button  (0-12 = 5).

8.7.2. Overview of serial interfaces

	RS 485	RS 232	Current-Loop, TTY passive
Mode of transmission	symmetrical	asymmetrical	symmetrical
length of cable max.	1200 m	15 m	300 m
Number of transmitter	32	1	1
Number of receiver	32	1	
Number of wires	2	3/5	2
Transmitter output unused max.	± 5 V	± 15 V	20 mA
Transmitter output used min.	± 1,5 V	± 5 V	20 mA (*)
Receiver input min.	± 0,3 V	± 3 V	10 mA

(*) only when maximal burden is not exceeded

8.8. Programming quick reference

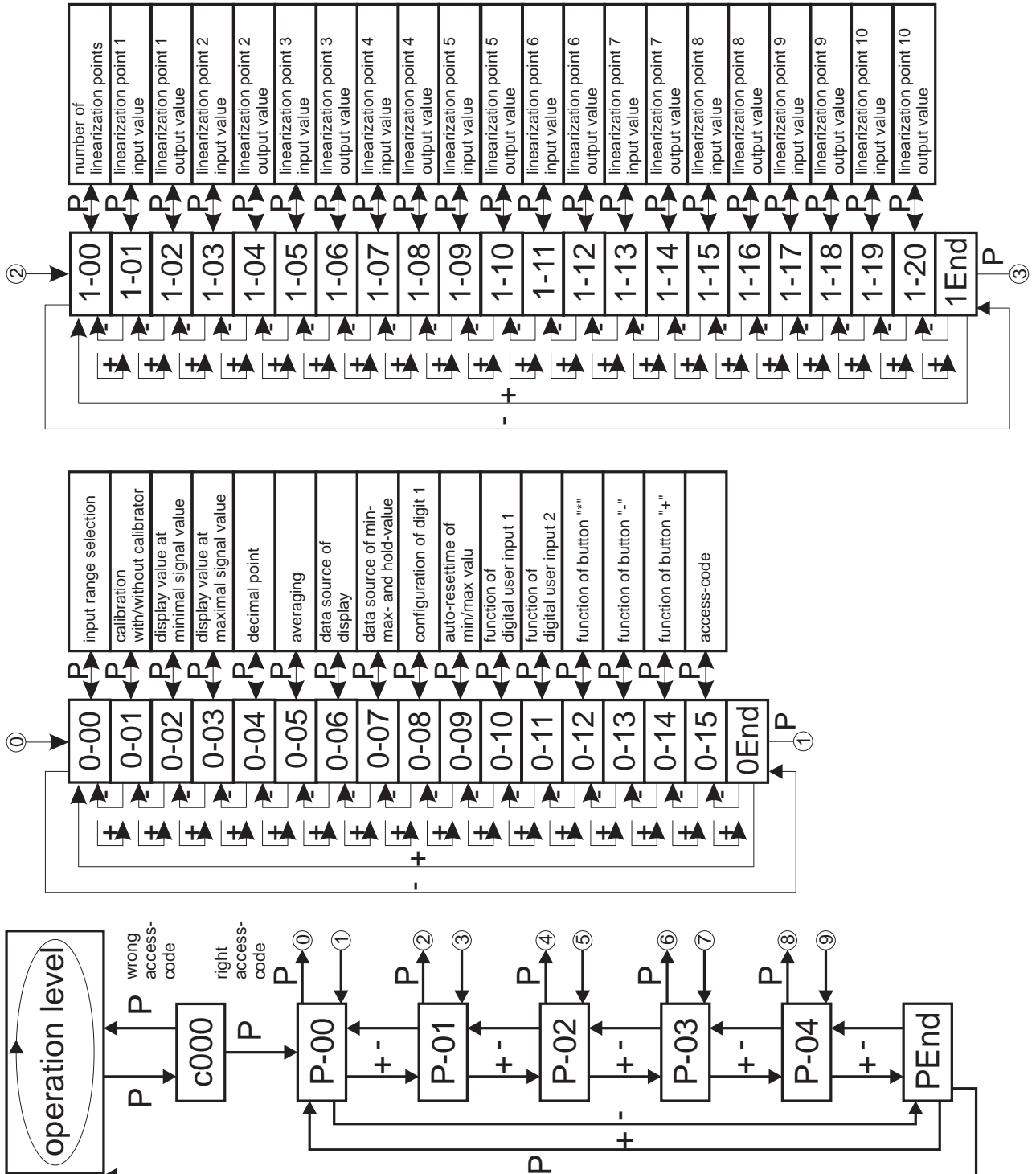

8. Procedure of programming

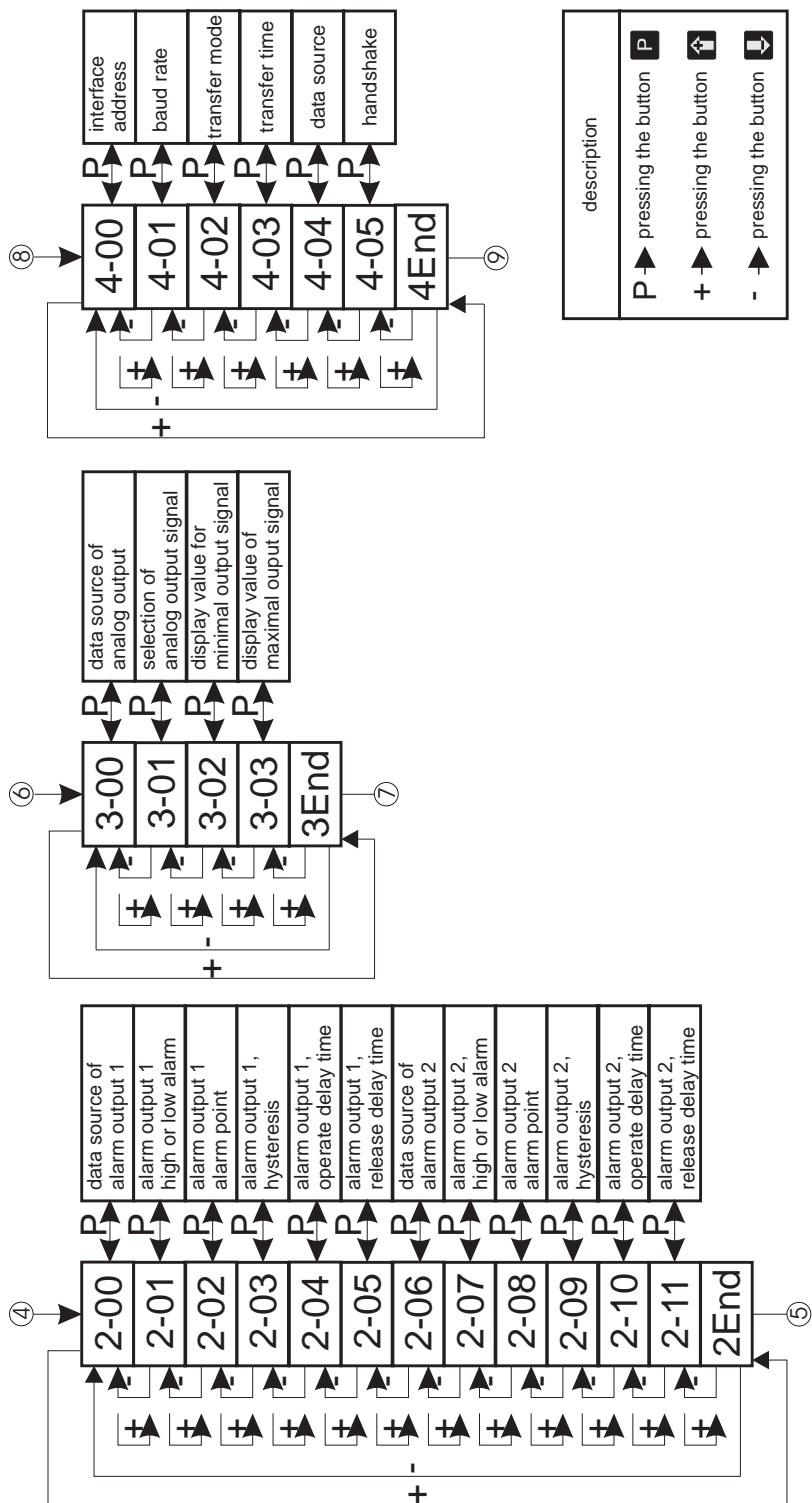

9. Software functionsn



9.1. MIN/MAX value detection

The panel meter include a MIN/MAX value detection. The maximum and minimum value can be displayed with the frontal push buttons or the digital user inputs. Besides the maximum and minimum value can be controlled of the alarm output or can be used as the data source for the analog output.

Reset the maximum and minimum values:

- Automatically by the programmed memory reset time (parameter 0-09)
- By activating the digital inputs 1 or 2 (parameter 0-10 and 0-11)
- By pressing the functional pushbutton  (parameter 0-12)
- By leaving the programming routine

Display the maximum and minimum value

- By programming as data source of the display (parameter 0-06)
- By activating the digital input 1 or 2 (parameter 0-10 and 0-11)
- By pressing the pushbutton  or  (parameter 0-13 and 0-14)

Indication of the displayed maximum and minimum value

- LED 3 lights green => maximum value is displayed
- LED 3 lights red => minimum value is displayed

9.2. Averaging

The panel meter includes a programmable single pole digital filter. The filter is used to smooth analog input data in noisy environments.

Digital filtering is performed by forming the average of input signals. By a special algorithm it is provided that a smooth filtering will be achieved.

$$\text{time constant} = \frac{\text{number of measurements}}{\text{conversion rate}}$$

If the input signal is a step function, 99,3 % of the final measurement value will be reached within 5 time constants.

9.3. *Taring*

By activating the tara function, the direct input value will be taken over into the tara memory. The tara value is being subtract from the direct input value and effect of the direct input value and the mean value.

Activating the tara function by:

- The digital input 1 (parameter 0-10)
- The digital input 2 (parameter 0-11)
- The functional pushbutton  (parameter 0-12)

Clear the tara value by:

- Activating the digital input 1 (parameter 0-10)
- Activating the digital input 2 (parameter 0-11)
- Pressing the functional pushbutton  (parameter 0-12)

Reset the tara value by:

- Changing the parameter 0-02 or 0-03
- Changing the input range (parameter 0-00)

9.4. *Display hold*

When activating the hold function the value of the data source, which is programmed in parameter 0-07 is taken over into the hold memory. If the hold function is not active the hold value is the same as the value of the data source, which is programmed in parameter 0-07.



Activating the hold function by:

- Digital input 1 (parameter 0-10)
- Digital input 2 (parameter 0-11)

Reset the hold value

- By leaving the programming routine

Display the hold value by

- Programming as data source of the display (parameter 0-06)
- Pressing the pushbutton  or  (parameter 0-13 and 0-14)

The hold value can:

- Show on display
- Watched by alarm output
- Set to the analog output

9.5. Display test

When activating the display test all segments of the display are light on. The display shows "8.8.8.8.8.8."

Activating the display test by:

- Digital input 1 (parameter 0-10)
- Digital input 2 (parameter 0-11)

9.6. Main reset

The main reset is performed by pressing a key combination at the front of the panel meter. By doing this all parameters are setting to the default value. The value of the parameter 0-00 (input range) is not changing by the main reset.

During the main reset the display shows "Init."

Perform the main reset by

Pressing the pushbuttons  ,  and  at the same time during 10 seconds

10. Technical Specifications

10.1. Electrical datas

Input ranges

DMS (straingage bridge) : 1 mV/V, 1,5 mV/V, 2 mV/V, 3 mV/V
: bipolar

Accuracy : 0,5 % at 3 mV/V

Bridge voltage : 9 V DC \pm 2 %, 40 mA

A/D-Converter resolution

: 16 Bit

Conversion rate

: 5 measurings per sec

Digital user inputs

: 10 k Ω to +5 V

Logic : NPN, max. 30 V

Signal level : L-Pegel < 0,4 V

: H-Pegel > 3,5 V

Alarm outputs

: 2 relays (programmable as
opened contact or closed contact)

Signaling : 2 LEDs at the front

Switch voltage : 250 V AC / 250 V DC

Switch current : 5 A AC / 5 A DC

Switch power : 750 VA / 100 W

Option analog output

: resolution 16 bit

Accuracy : \pm 0,2 % of final value

Voltage : 0/2 - 10 V, max. 10 mA

Current : 0/4 - 20 mA, max. 500 Ω

Isolation voltage : 3 kV / 1 min

Option interfaces

: RS 485, RS 232, TTY

Protocol : DIN 66 019 / ISO 1745

Baud rate : 300, 1200, 2400, 4800, 9600, 19200

Data format : 1 Start, 8 Data, N-Parity, 1 Stop

Isolation voltage : 1,6 kV / 1 min

Power supply AC

: 95 .. 250 V AC

Power consumption : approx. 9 VA

Isolation voltage : 2,5 kV / 1 min

Option power supply DC

: 18 .. 36 V DC

Power consumption : approx. 70 mA

Isolation voltage : 500 V / 1 min

Accessory power supply (only at AC)

: 24 V DC \pm 10 %, max. 125 mA

Isolation voltage : 500 V / 1 min

10.2. Mechanical datas

Display	: 6 decades, 14 mm, red : decimal point programmable : preliminary zero suppression : - sign at negative values
Operation, keyboard design	: front membrane with push buttons
Case	: switch board mounting DIN 43 700
Dimensions (B x H x T)	: 96 x 48 x 141 mm
Depth	: 148 mm incl. screw terminal
Mounting	: switch board mounting or : mosaic-system mounting
Weight	: approx. 400 g
Connection	: plug-in screw terminal
Signal inputs	: max. \square 1,5 mm ²
Alarm outputs	: max. \square 2,5 mm ²
Power inputs	: max. \square 2,5 mm ²

10.3. Environmental conditions

Operating temperature	: 0 .. 50 °C
Storage temperature	: -20 .. 70 °C
Humidity	: < 80 %, not-condensing
Protection	: protection class II
Front protection	: IP 54 : connectors IP 20
Field of application	: class 2 : overvoltage protection II
CE	: in conform with 89/336/EWG : NSR 73/23/EWG

11. Ordering information

DM 3002 -						
						Housing
						0 switch board mounting
						1 panel-Clip mounting
						Front frame color
						0 black
						Front design
						0 ERMA-Meter logo
						1 no logo
						2 customer defined logo
						Power supply
						0 95 .. 250 V AC
						1 18 .. 36 V DC, isolated
						Option interface
						0 no interface
						1 Interface RS 485
0						2 Interface RS 232
0						3 interface Current-Loop, TTY
						Options
						0 no options
						1 with analog output
						4 2 additional alarm outputs (relay) (*)

(*) in preparation

12. Notices

ERMA - Electronic GmbH
Max-Eyth-Straße 8
D-78194 Immendingen

Telefon +49 7462 7381
Fax +49 7462 7554
email erma-electronic@t-online.de

